

MITSUBISHI

Mitsubishi Programmable Controller

CC-Link IE Field Network Digital-Analog Converter Module User's Manual

-NZ2GF2B-60DA4

MODEL

● SAFETY PRECAUTIONS ●

(Read these precautions before using this product.)

Before using this product, please read this manual and the relevant manuals carefully and pay full attention to safety to handle the product correctly.

The precautions given in this manual are concerned with this product only. For the safety precautions of the programmable controller system, refer to the user's manual for the CPU module used.

In this manual, the safety precautions are classified into two levels: "⚠ WARNING" and "⚠ CAUTION".



Indicates that incorrect handling may cause hazardous conditions, resulting in death or severe injury.

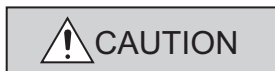

Indicates that incorrect handling may cause hazardous conditions, resulting in minor or moderate injury or property damage.

Under some circumstances, failure to observe the precautions given under "⚠ CAUTION" may lead to serious consequences.

Observe the precautions of both levels because they are important for personal and system safety.

Make sure that the end users read this manual and then keep the manual in a safe place for future reference.

[Design Precautions]

⚠ WARNING

- In the case of a communication failure in the network, data in the master module are held. Check Data link status (each station) (SW00B0 to SW00B7) and configure an interlock circuit in the program to ensure that the entire system will operate safely.
- Do not use any "use prohibited" signals as a remote input or output signal. These signals are reserved for system use. Do not write any data to the "use prohibited" area in the remote register. If these operations are performed, correct operation of the module cannot be guaranteed.
- Configure safety circuits external to the programmable controller to ensure that the entire system operates safely even when a fault occurs in the external power supply or the programmable controller. Failure to do so may result in an accident due to an incorrect output or malfunction.
 - (1) The status of analog output depends on the setting of various functions that control the analog output. Exercise great caution when setting those functions. For details of analog output status, refer to the Page 76, Section 8.4.
 - (2) Due to failure of the output element or internal circuit, normal output may not be obtained correctly. Configure an external circuit for monitoring output signals that could cause a serious accident.

[Design Precautions]

CAUTION

- Do not install the control lines or communication cables together with the main circuit lines or power cables. Keep a distance of 100mm or more between them. Failure to do so may result in malfunction due to noise.
- At power-on or power-off, a voltage may occur or a current may flow between output terminals for a moment. In this case, start the control after analog outputs become stable.

[Installation Precautions]

WARNING

- Shut off the external power supply (all phases) used in the system before mounting or removing a module. Failure to do so may result in electric shock or cause the module to fail or malfunction.

[Installation Precautions]

CAUTION

- Use the module in an environment that meets the general specifications in this manual. Failure to do so may result in electric shock, fire, malfunction, or damage to or deterioration of the product.
- Securely fix the module with a DIN rail.
- Do not directly touch any conductive parts and electronic components of the module. Doing so can cause malfunction or failure of the module.
- After the first use of the product (extension module), the number of connections/disconnections is limited to 50 times (IEC 61131-2 compliant).
- To connect an extension module to a main module, engage the respective connectors and securely lock the module joint levers. Incorrect connection may cause malfunction, failure, or drop of the module.
- Securely connect the cable connectors. Poor contact may cause malfunction.

[Wiring Precautions]

WARNING

- Shut off the external power supply (all phases) used in the system before wiring. Failure to do so may result in electric shock or cause the module to fail or malfunction.

[Wiring Precautions]

CAUTION

- Individually ground the FG terminal of the programmable controller with a ground resistance of 100Ω or less. Failure to do so may result in electric shock or malfunction.
- Tighten any unused terminal screws within the specified torque range. Undertightening may cause a short circuit due to contact with a solderless terminal.

[Wiring Precautions]

CAUTION

- Use applicable solderless terminals and tighten them within the specified torque range. If any spade solderless terminal is used, it may be disconnected when a terminal block screw comes loose, resulting in failure.
- Check the rated voltage and terminal layout before wiring to the module, and connect the cables correctly. Connecting a power supply with a different voltage rating or incorrect wiring may cause a fire or failure.
- Tighten the terminal block screws within the specified torque range. Undertightening can cause short circuit, fire, or malfunction. Overtightening can damage the screw and/or module, resulting in drop, short circuit, fire, or malfunction.
- Prevent foreign matter such as dust or wire chips from entering the module. Such foreign matter can cause a fire, failure, or malfunction.
- Place the cables in a duct or clamp them. If not, dangling cable may swing or inadvertently be pulled, resulting in damage to the module or cables or malfunction due to poor contact.
- Do not install the control lines or communication cables together with the main circuit lines or power cables. Keep a distance of 100mm or more between them. Failure to do so may result in malfunction due to noise.
- When disconnecting the cable from the module, do not pull the cable by the cable part. For the cable with connector, hold the connector part of the cable. For the cable connected to the terminal block, loosen the terminal screw. Pulling the cable connected to the module may result in malfunction or damage to the module or cable.
- When an overcurrent caused by an error of an external device or a failure of the programmable controller flows for a long time, it may cause smoke and fire. To prevent this, configure an external safety circuit, such as a fuse.
- Mitsubishi programmable controllers must be installed in control panels. Wiring and replacement of a module must be performed by qualified maintenance personnel with knowledge of protection against electric shock. For wiring methods, refer to "INSTALLATION AND WIRING" in this manual.

[Startup and Maintenance Precautions]

WARNING

- Do not touch any terminal while power is on. Doing so will cause electric shock or malfunction.
- Shut off the external power supply (all phases) used in the system before cleaning the module or retightening the terminal block screws. Failure to do so may cause the module to fail or malfunction.

[Startup and Maintenance Precautions]

CAUTION

- Do not disassemble or modify the module. Doing so may cause failure, malfunction, injury, or a fire.
- Do not drop or apply strong shock to the module. Doing so may damage the module.
- Shut off the external power supply (all phases) used in the system before mounting or removing a module. Failure to do so may cause the module to fail or malfunction.

[Startup and Maintenance Precautions]

CAUTION

- After the first use of the product (terminal block), the number of connections/disconnections is limited to 50 times (IEC 61131-2 compliant).
- Before handling the module or the cable to be connected to the module, touch a conducting object such as a grounded metal to discharge the static electricity from the human body. Failure to do so may cause the module to fail or malfunction.
- Startup and maintenance of a control panel must be performed by qualified maintenance personnel with knowledge of protection against electric shock. Lock the control panel so that only qualified maintenance personnel can operate it.

[Disposal Precautions]

CAUTION

- When disposing of this product, treat it as industrial waste.

● CONDITIONS OF USE FOR THE PRODUCT ●

- (1) Mitsubishi programmable controller ("the PRODUCT") shall be used in conditions;
- i) where any problem, fault or failure occurring in the PRODUCT, if any, shall not lead to any major or serious accident; and
 - ii) where the backup and fail-safe function are systematically or automatically provided outside of the PRODUCT for the case of any problem, fault or failure occurring in the PRODUCT.
- (2) The PRODUCT has been designed and manufactured for the purpose of being used in general industries.

MITSUBISHI SHALL HAVE NO RESPONSIBILITY OR LIABILITY (INCLUDING, BUT NOT LIMITED TO ANY AND ALL RESPONSIBILITY OR LIABILITY BASED ON CONTRACT, WARRANTY, TORT, PRODUCT LIABILITY) FOR ANY INJURY OR DEATH TO PERSONS OR LOSS OR DAMAGE TO PROPERTY CAUSED BY the PRODUCT THAT ARE OPERATED OR USED IN APPLICATION NOT INTENDED OR EXCLUDED BY INSTRUCTIONS, PRECAUTIONS, OR WARNING CONTAINED IN MITSUBISHI'S USER, INSTRUCTION AND/OR SAFETY MANUALS, TECHNICAL BULLETINS AND GUIDELINES FOR the PRODUCT.

("Prohibited Application")

Prohibited Applications include, but not limited to, the use of the PRODUCT in;

- Nuclear Power Plants and any other power plants operated by Power companies, and/or any other cases in which the public could be affected if any problem or fault occurs in the PRODUCT.
- Railway companies or Public service purposes, and/or any other cases in which establishment of a special quality assurance system is required by the Purchaser or End User.
- Aircraft or Aerospace, Medical applications, Train equipment, transport equipment such as Elevator and Escalator, Incineration and Fuel devices, Vehicles, Manned transportation, Equipment for Recreation and Amusement, and Safety devices, handling of Nuclear or Hazardous Materials or Chemicals, Mining and Drilling, and/or other applications where there is a significant risk of injury to the public or property.

Notwithstanding the above, restrictions Mitsubishi may in its sole discretion, authorize use of the PRODUCT in one or more of the Prohibited Applications, provided that the usage of the PRODUCT is limited only for the specific applications agreed to by Mitsubishi and provided further that no special quality assurance or fail-safe, redundant or other safety features which exceed the general specifications of the PRODUCTS are required. For details, please contact the Mitsubishi representative in your region.

INTRODUCTION

Thank you for purchasing the CC-Link IE Field Network D/A converter module (hereafter abbreviated as D/A converter module).

This manual describes the operating procedure, system configuration, parameter settings, functions, and troubleshooting of the D/A converter module.

Before using this product, please read this manual and the relevant manuals carefully and develop familiarity with the functions and performance of the D/A converter module to handle the product correctly.

When applying the program examples introduced in this manual to an actual system, ensure the applicability and confirm that it will not cause system control problems.

■ Target module: NZ2GF2B-60DA4

Remark

Unless otherwise specified, this manual describes the program examples in which the remote I/O signals and remote registers are assigned for a D/A converter module as follows.

- Remote input signal: RX0 to RX1F
- Remote output signal: RY0 to RY1F
- Remote register: RWr0 to RWrF, RWw0 to RWwF

For the assignment of remote I/O signals and remote registers, refer to the following.

 User's manual for the master/local module used

RELEVANT MANUALS

(1) CC-Link IE Field Network (relevant) manuals

When using the CC-Link IE Field Network for the first time, refer to CC-Link IE Field Network Master/Local Module User's Manual first. The following shows the structure of the CC-Link IE Field Network manuals.

Manual name <manual number (model code)>	Description
MELSEC-Q CC-Link IE Field Network Master/Local Module User's Manual <SH-080917ENG, 13JZ47>	Overview of the CC-Link IE Field Network, and specifications, procedures before operation, system configuration, installation, wiring, settings, functions, programming, and troubleshooting of the QJ71GF11-T2
MELSEC-L CC-Link IE Field Network Master/Local Module User's Manual <SH-080972ENG, 13JZ54>	Overview of the CC-Link IE Field Network, and specifications, procedures before operation, system configuration, installation, wiring, settings, functions, programming, and troubleshooting of the LJ71GF11-T2

(2) Operating manual

Manual name <manual number (model code)>	Description
GX Works2 Version1 Operating Manual (Common) <SH-080779ENG, 13JU63>	System configuration, parameter settings, and online operations of GX Works2, which are common to Simple projects and Structured projects

CONTENTS

SAFETY PRECAUTIONS	1
CONDITIONS OF USE FOR THE PRODUCT	5
INTRODUCTION	6
RELEVANT MANUALS	7
MANUAL PAGE ORGANIZATION	11
TERM.	12
PACKING LIST	14
<hr/>	
CHAPTER 1 D/A CONVERTER MODULE	15
<hr/>	
1.1 Application	15
1.2 Features	16
<hr/>	
CHAPTER 2 PART NAMES	19
<hr/>	
CHAPTER 3 SPECIFICATIONS	23
<hr/>	
3.1 General Specifications	23
3.2 Performance Specifications	25
3.3 Calculating Current Consumption	27
3.4 Function List	28
3.5 List of Remote I/O Signals	29
3.6 List of Remote Register	31
3.7 List of Remote Buffer Memory	32
<hr/>	
CHAPTER 4 THE PROCEDURE BEFORE OPERATION	41
<hr/>	
CHAPTER 5 SYSTEM CONFIGURATION	43
<hr/>	
5.1 D/A Converter Module System Configuration	43
5.2 Applicable Systems	44
<hr/>	
CHAPTER 6 INSTALLATION AND WIRING	45
<hr/>	
6.1 Station Number Setting	45
6.2 Installation Environment and Installation Position	46
6.2.1 Installation environment	46
6.2.2 Installation position	46
6.2.3 Installation direction	47
6.3 Installation	48
6.3.1 Connecting extension modules	48
6.3.2 Mounting the modules on a DIN rail	49
6.4 Wiring with Terminal Block for Module Power Supply and FG	52
6.5 Wiring of Ethernet Cable	54
6.6 Wiring of External Device and Terminal Block	57

CHAPTER 7 VARIOUS SETTINGS	63
7.1 Parameter Setting	63
7.2 Changing the Parameter	68
7.2.1 Changing the network configuration	68
7.2.2 Changing the parameter without changing the network configuration	70
7.3 Offset/Gain Setting	72
CHAPTER 8 FUNCTION	74
8.1 D/A Conversion Enable/Disable Function	74
8.2 D/A Output Enable/Disable Function	74
8.3 Range Switching Function	75
8.4 Analog Output HOLD/CLEAR Function	76
8.5 Cyclic Data Update Watch Function	78
8.6 Scaling Function	79
8.7 Shift Function	85
8.8 Digital Value Range Check Function	89
8.9 Alert Output Function	92
8.10 Error Notification Function	95
8.11 Function at the Extension Module Installation	98
8.12 CC-Link IE Field Network Diagnostic Function	102
CHAPTER 9 PROGRAMMING	105
9.1 Precautions for Programming	105
9.2 Procedure for Programming	106
9.3 Program Example	106
CHAPTER 10 MAINTENANCE AND INSPECTION	114
CHAPTER 11 TROUBLESHOOTING	116
11.1 Checking for the Error Codes and the Alarm Codes	116
11.2 Error Code List	119
11.3 Alarm Code List	124
11.4 Checking the LEDs	125
11.5 Unit Test	128
11.6 Troubleshooting for Each Phenomenon	129
APPENDICES	131
Appendix 1 Details of Remote I/O Signals	131
Appendix 1.1 Remote input signals	131
Appendix 1.2 Remote output signals	135
Appendix 2 Details of Remote Register Areas	136
Appendix 3 Details of Remote Buffer Memory Areas	140

Appendix 4 I/O Conversion Characteristic of D/A Conversion	152
Appendix 5 Accuracy of D/A Conversion	155
Appendix 6 Conversion Speed of D/A Conversion	155
Appendix 7 EMC and Low Voltage Directives	156
Appendix 7.1 Measures to comply with the EMC Directive	156
Appendix 7.2 Requirements to compliance with the Low Voltage Directive	162
Appendix 8 Checking Serial Number and Function Version	163
Appendix 9 External Dimensions	164

INDEX	166
REVISIONS	168
WARRANTY	169

MANUAL PAGE ORGANIZATION

In this manual, pages are organized and the symbols are used as shown below.

The following illustration is for explanation purpose only, and should not be referred to as an actual documentation.

Annotations for the manual page screenshot:

- "" is used for screen names and items.
- 1. shows operating procedures.
- ☞ shows mouse operations.*1
- [] is used for items in the menu bar and the project window.
- Ex. shows setting or operating examples.
- 📖 shows reference manuals.
- 👉 shows reference pages.
- Point shows notes that requires attention.
- Remark shows useful information.

Manual page content (73):

CHAPTER 7 VARIOUS SETTINGS

7.1.1 Setting method

(1) Setting parameters

(a) Operating procedure

1. Open the "PLC Parameter" dialog box.
Project window ⇨ [Parameter] ⇨ [PLC parameter]
2. Select the "IO Assignment" tab.

Item	Description	Reference
Type	Select the type of the connected module.	Page 74, Section 7.1.2
Model Name	Select the model name of the connected module.	Page 74, Section 7.1.3
Points	Set the number of points assigned to each slot.	Page 74, Section 7.1.4
Start XY	Specify a start I/O number for each slot.	Page 74, Section 7.1.5
Switch setting	Configure the switch setting of the built-in I/O or intelligent function modules.	Page 74, Section 7.1.6
General setting	Set the following: • Error Time Output Mode • PLC Operation Mode at HW Error • I/O Response Time	Page 75, Section 7.1.7

Setting "Start XY" enables modification on the start I/O numbers assigned to connected modules.
Ex. When "1000" is specified in "Start XY" to the slot where a 16-point module is connected, the assignment range of an input module is changed to X1000 to X100F.

For details, refer to the following:
MELSEC-L CPU Module User's Manual (Function Explanation, Program Fundamentals)

Point
Set the type of the connected module in "Type". Setting a different type results in "SPUNIT LAY ERR."
For the intelligent function module, the I/O points must also be the same in addition to the I/O assignment setting.
Page 30, Section 4.2.2)

Remark
When an intelligent module is connected, I/O assignment can be omitted by selecting connected modules from "Intelligent Function Module" in the Project window.





*1 The mouse operation example is provided below.

Annotations for the software interface screenshot:

- Menu bar: Ex. ☞ [Online] ⇨ [Write to PLC...]
Select [Online] on the menu bar, and then select [Write to PLC...].
- A window selected in the view selection area is displayed. Ex. ☞ Project window ⇨ [Parameter] ⇨ [PLC Parameter]
Select [Project] from the view selection area to open the Project window. In the Project window, expand [Parameter] and select [PLC Parameter].
- View selection area

TERM

Unless otherwise specified, this manual uses the following terms.

Term	Description
CC-Link IE Field Network	A high-speed and large-capacity open field network that is based on Ethernet (1000BASE-T)
D/A converter module	Another term for the CC-Link IE Field Network D/A converter module
GX Works2	The product name of the software package for the MELSEC programmable controllers
REMFR	The abbreviation for ZP.REMFR
REMTO	The abbreviation for ZP.REMTO
Intelligent device station	A station that exchanges I/O signals (bit data) and I/O data (word data) with another station by cyclic transmission. This station responds to a transient transmission request from another station and also issues a transient transmission request to another station.
Cyclic transmission	A function by which data are periodically exchanged among stations on the same network using link devices (RX, RY, RWw, and RWr)
Slave station	A generic term for stations other than a master station, such as a local station, remote I/O station, remote device station, and intelligent device station
Data link	Generic term for cyclic transmission and transient transmission
Transient transmission	A function of communication with another station, which is used when requested by a dedicated instruction or GX Works2
Network module	A generic term for the following modules: <ul style="list-style-type: none"> • CC-Link IE Field Network module • CC-Link IE Controller Network module • Ethernet interface module • MELSECNET/H module • MELSECNET/10 module
Buffer memory	A memory in an intelligent function module, where data (such as setting values and monitoring values) exchanged with a CPU module are stored
Master/local module	A generic term for the CC-Link IE Field Network master/local module
Master station	A station that controls the entire network. This station can perform cyclic transmission and transient transmission with all stations. Only one master station can be used in a network.
Remote I/O station	A station that exchanges I/O signals (bit data) with the master station by cyclic transmission
Remote device station	A station that exchanges I/O signals (bit data) and I/O data (word data) with another station by cyclic transmission. This station responds to a transient transmission request from another station.
Remote buffer memory	Buffer memory in a remote device station
Remote register (RWr)	Word data input from a slave station to the master station (For some areas in a local station, data are input in the opposite direction.)  User's manual for the master/local module used
Remote register (RWw)	Word data output from the master station to a slave station (For some areas in a local station, data are output in the opposite direction.)  User's manual for the master/local module used
Remote output (RY)	Bit data output from the master station to a slave station (For some areas in a local station, data are output in the opposite direction.)  User's manual for the master/local module used
Remote input (RX)	Bit data input from a slave station to the master station (For some areas in a local station, data are input in the opposite direction.)  User's manual for the master/local module used
Link device	A device (RX, RY, RWr, or RWw) in a module on CC-Link IE Field Network
Link special relay (SB)	Bit data that indicates the operating status and data link status of a module on CC-Link IE Field Network
Link special register (SW)	Word data that indicates the operating status and data link status of a module on CC-Link IE Field Network
Local station	A station that performs cyclic transmission and transient transmission with the master station and other local stations. The station is controlled by programs in the CPU module or other equivalent modules on the station.
Disconnection	A process of stopping data link if a data link error occurs

Term	Description
Main module	A module with the CC-Link IE Field Network communication function, which can be used as a single remote module. Extension modules can be connected to this module.
Dedicated instruction	An instruction that simplifies programming for using functions of intelligent function modules
Extension module	A remote module that does not support the CC-Link IE Field Network communication function. This module cannot be used as a single module. However, connecting the module to the main module will increase the number of I/O points per station.
Extension I/O module	A generic term for extension modules where a digital signal can be input or output
Relay station	A station that includes two or more network modules. Data are passed through this station to stations on other networks.
I/O module	Another term for the CC-Link IE Field Network remote I/O module
Return	Process of restarting data link when a station recovers from an error
Reserved station	A station reserved for future use. This station is not actually connected, but counted as a connected station.

PACKING LIST

The following items are included in the package of this product. Before use, check that all the items are included.

D/A converter module

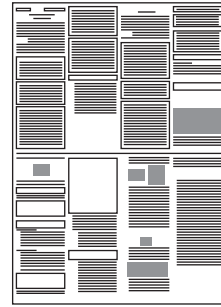
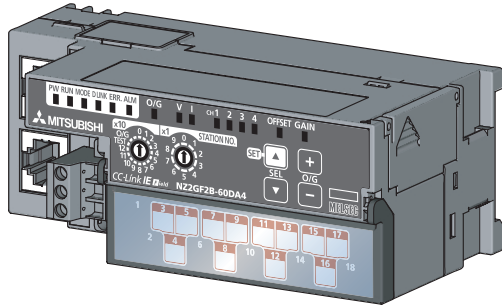

Module

Before Using the Product

CHAPTER 1 D/A CONVERTER MODULE

This chapter describes the applications and features of the D/A converter module.

1.1 Application

This module converts the digital data to the analog signal and outputs it to the external devices.

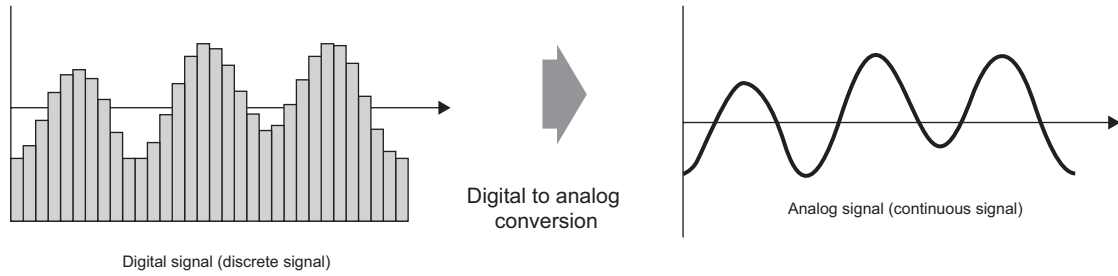

The digital data is set from the master station.
The D/A converter module enables works as follows.

The flow and temperature can be controlled from the master station by using the D/A converter module.

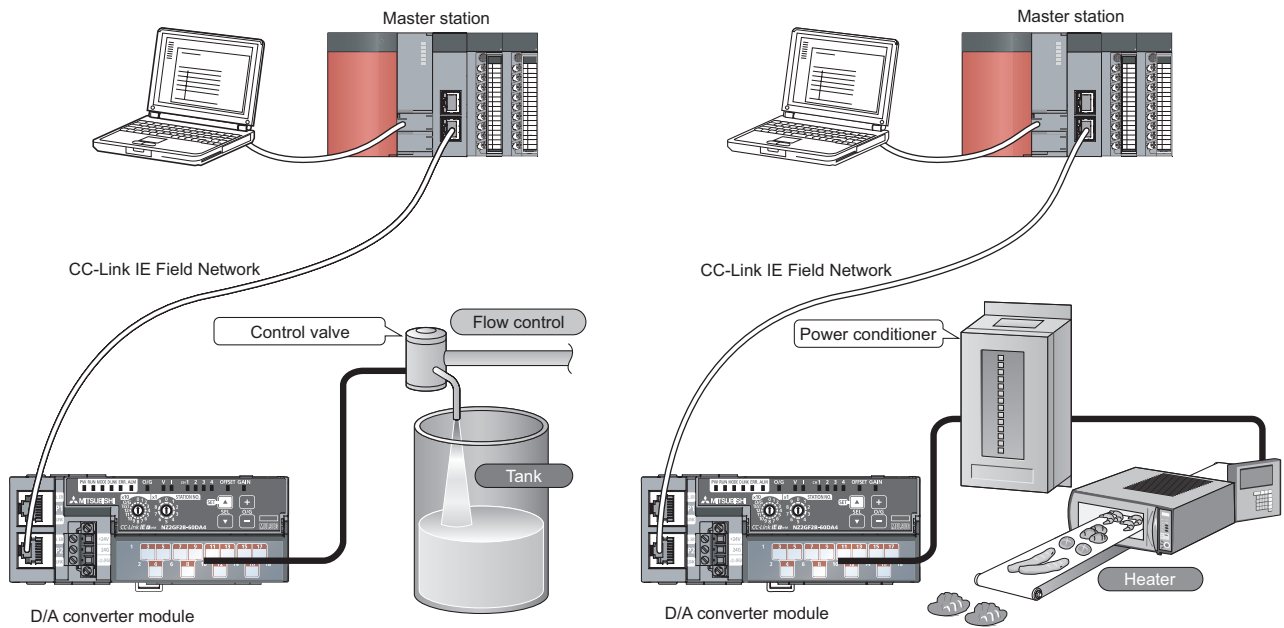

1.2 Features

(1) Available flexible system configuration

Adopting the connection block type enables the combination of the main module and extension module. Because various extension modules can be connected, a flexible configuration can be achieved. In addition a poor contact of the extension module can be found promptly because the main module always monitors the connection status of the extension module.

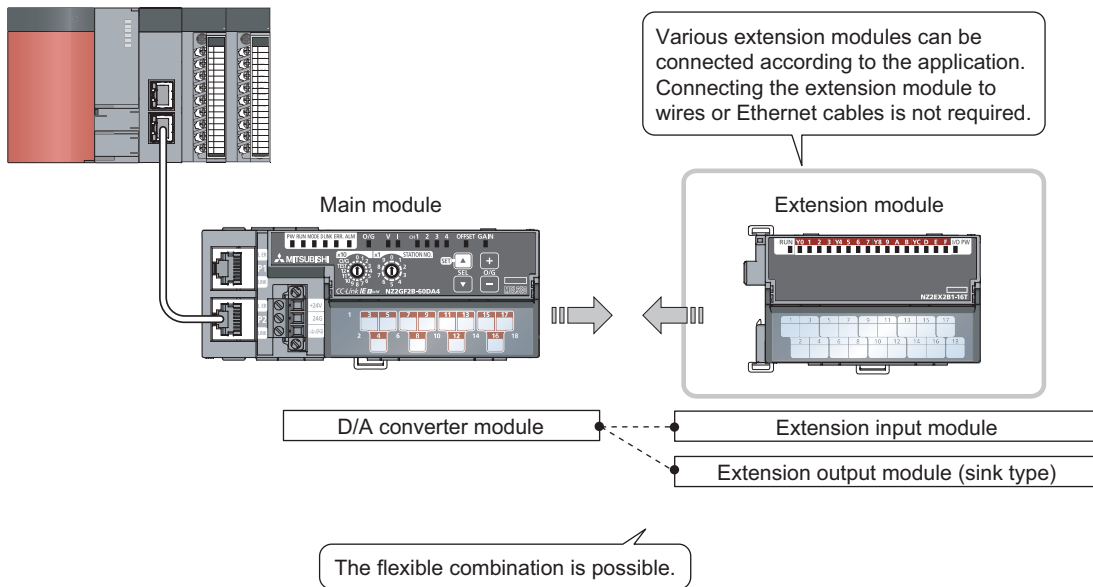

(2) Easy station number setting

Because of the rotary switch on the front of the module, setting and checking the station number are easy.

(3) Response improvement by high-speed conversion

The high-speed conversion of 100µs/channel is achieved.

(4) Reliability by high accuracy

High accuracy is achieved for the maximum value of analog output value: $\pm 0.2\%$ (ambient temperature: $25 \pm 5^\circ\text{C}$) and $\pm 0.3\%$ (ambient temperature: 0 to 55°C).

(5) Switching scale available

The D/A conversion value to be converted can be scale-converted to any range. The scale-conversion can be performed without a program according to the digital value to be input, thus the cost can be saved.

(6) Error detection and monitoring available

When a digital value exceeds the range set in advance, an alert is detected. Thus, an error of digital value can be monitored and outputs of a digital value can be limited.

(7) Output available without influence from the sequence scan or link scan

An error status or alert status can be output from the extension output module by using the external signal assignment function when an error or alert occurs.

The sequence scan or link scan does not influence this output.

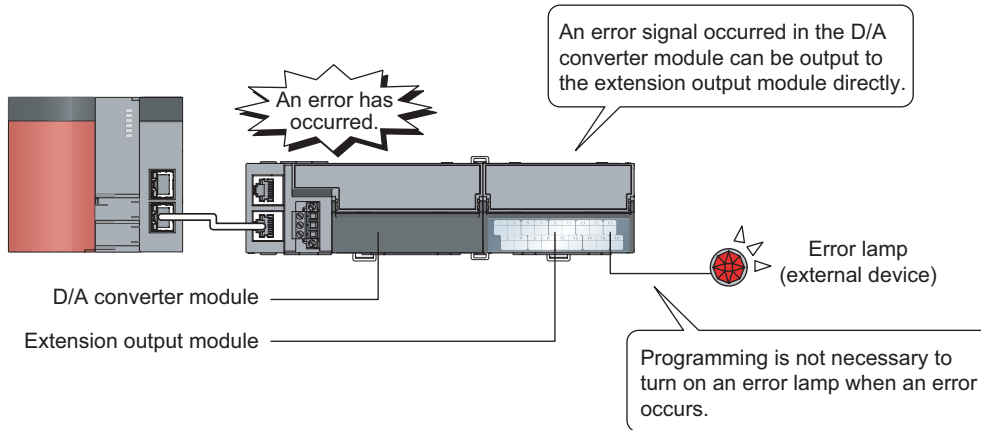

(8) Various installation methods

The module can be installed in six directions using a DIN rail.

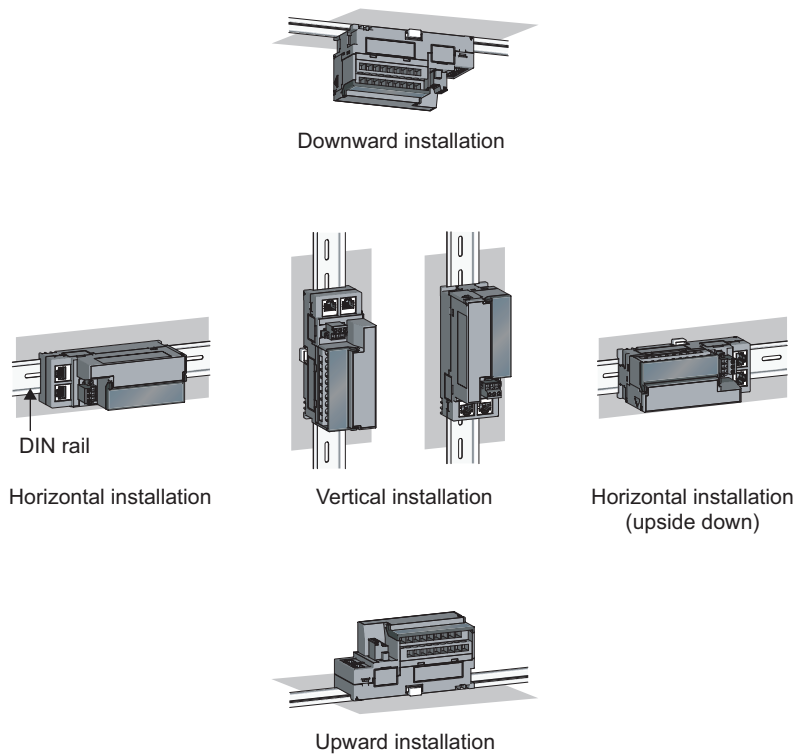

(9) Easy module replacement

Because the 2-piece structure is adopted for the terminal block for module power supply and FG and terminal block for analog output signals, the module can be replaced with the wire connected. In addition, because the terminal block for analog output signals is the lift-up structure, the terminal block can be lifted only by loosening the terminal block mounting screw to be removed easily.

(10) Error history confirmation

The history of 15 errors and occurrence time are stored in the D/A converter module.

The error history helps the investigation for the cause when a problem occurs.

(11) Easy setting with CC IE Field configuration of GX Works2

Programming is reduced since the parameter can be configured on the screen with the CC IE Field configuration of GX Works2. In addition, setting status and operation status of modules can be checked easily.

CHAPTER 2 PART NAMES

2

The section describes part names of the D/A converter module.

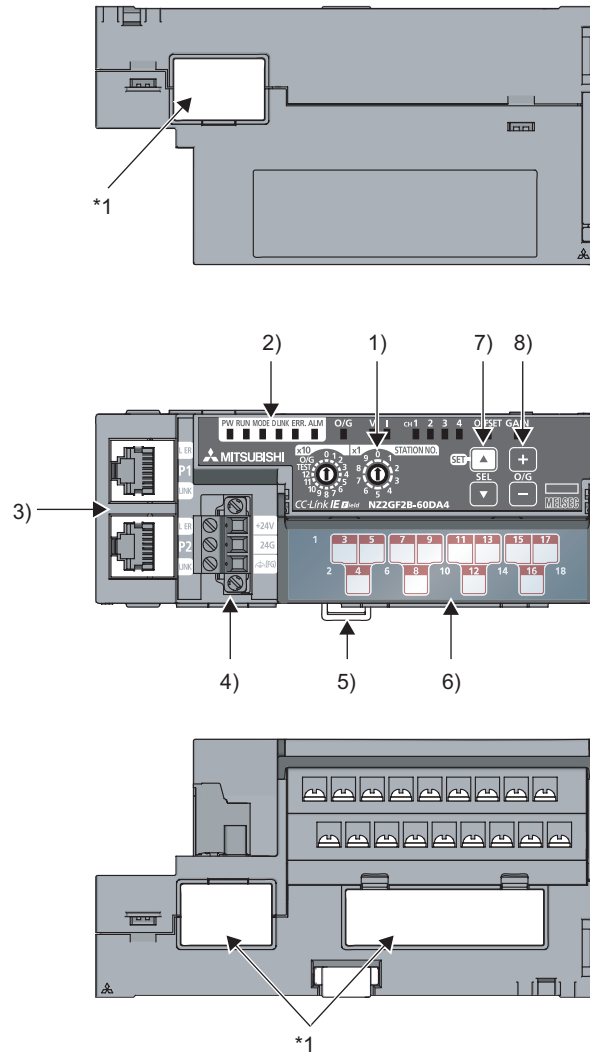

*1 Do not remove this seal because it is used for a maintenance purpose.

No.	Name	Application
1)	Station number setting switch	<p>A rotary switch for the following setting and test.</p> <ul style="list-style-type: none"> • Station Number Setting (Page 45, Section 6.1) • Offset/Gain Setting (Page 68, Section 7.2) • Unit Test (Page 128, Section 11.5) <p>When operating the station number setting switch, use a slotted screwdriver with 3.5mm or less width of the tip.</p>

No.	Name	Application								
2)	PW LED (green)	Indicates the operating status of the D/A converter module.								
	ON	Power supply ON								
	OFF	Power supply OFF								
	RUN LED (green)	Indicates the operating status of the D/A converter module.								
	ON	Operating normally. Writing data to the nonvolatile memory in the offset/gain setting mode.								
	OFF	A major error has occurred or in the offset/gain setting mode.								
	MODE LED (green)	Indicates the mode of the D/A converter module.								
	ON	In online mode.								
	Flashing	In unit test mode.								
	OFF	In offset/gain setting mode.								
	D LINK LED (green)	Indicates the data link status of the D/A converter module.								
	ON	Data link in operation. (cyclic transmission in progress)								
	Flashing	Data link in operation. (cyclic transmission stopped)								
	OFF	Data link not performed. (disconnected)								
	ERR. LED (red)	Indicates the error status of the D/A converter module.								
	ON	A moderate error or major error has occurred.								
	Flashing	A warning has occurred.								
	OFF	Operating normally.								
	ALM LED (red)	Indicates the alert status of the D/A converter module.								
	ON	Alert has occurred.								
Flashing	An out-of-range digital value error has occurred.									
OFF	Operating normally.									
O/G LED (green)	Indicates the module is in the offset/gain setting mode.									
ON	In offset/gain setting mode.									
OFF	In a mode other than the offset/gain setting mode.									
V LED (green) I LED (green)	Indicates the user range setting for the selected setting in the offset/gain setting mode.									
	<table border="1"> <thead> <tr> <th>Setting target</th> <th>V LED</th> <th>I LED</th> </tr> </thead> <tbody> <tr> <td>User range setting 1 (voltage)</td> <td>ON</td> <td>OFF</td> </tr> <tr> <td>User range setting 2 (current)</td> <td>OFF</td> <td>ON</td> </tr> </tbody> </table>	Setting target	V LED	I LED	User range setting 1 (voltage)	ON	OFF	User range setting 2 (current)	OFF	ON
Setting target	V LED	I LED								
User range setting 1 (voltage)	ON	OFF								
User range setting 2 (current)	OFF	ON								
CH1 to 4 LED (green)	Indicates the channel for the selected setting in the offset/gain setting mode.									
ON	The channel of the number for which the LED turns on is the setting target.									
OFF	The channel of the number for which the LED turns off is not the setting target.									
OFFSET LED (green), GAIN LED (green)	Indicates whether the selected setting is offset or gain in the offset/gain setting mode.									
	<table border="1"> <thead> <tr> <th>Setting target</th> <th>OFFSET LED</th> <th>GAIN LED</th> </tr> </thead> <tbody> <tr> <td>Offset</td> <td>ON</td> <td>OFF</td> </tr> <tr> <td>Gain</td> <td>OFF</td> <td>ON</td> </tr> </tbody> </table>	Setting target	OFFSET LED	GAIN LED	Offset	ON	OFF	Gain	OFF	ON
Setting target	OFFSET LED	GAIN LED								
Offset	ON	OFF								
Gain	OFF	ON								

No.	Name	Application				
3)	P1	PORT1 connector for CC-Link IE Field Network (RJ45 connector) Connect an Ethernet cable. (☞ Page 54, Section 6.5) There are no restrictions on the connection order of the cables for the "P1" connector and "P2" connector.				
		<table border="1"> <tr> <td rowspan="2">L ER LED (red)</td> <td>ON</td> <td> <ul style="list-style-type: none"> The module has received abnormal data. The module is performing loopback. </td> </tr> <tr> <td>OFF</td> <td> <ul style="list-style-type: none"> The module has received normal data. The module is not performing loopback. </td> </tr> </table>	L ER LED (red)	ON	<ul style="list-style-type: none"> The module has received abnormal data. The module is performing loopback. 	OFF
	L ER LED (red)	ON		<ul style="list-style-type: none"> The module has received abnormal data. The module is performing loopback. 		
		OFF	<ul style="list-style-type: none"> The module has received normal data. The module is not performing loopback. 			
	LINK LED (green)	ON	Linkup in progress.			
		OFF	Linkdown in progress.			
P2	PORT2 connector for CC-Link IE Field Network (RJ45 connector) Connect an Ethernet cable. (☞ Page 54, Section 6.5) There are no restrictions on the connection order of the cables for the "P1" connector and "P2" connector.					
	L ER LED (red)	(Same as the "P1" connector)				
	LINK LED (green)					
4)	Terminal block for module power supply and FG	A terminal block to connect the module power supply (24VDC) and FG.				
5)	DIN rail hook	A hook to mount a module on a DIN rail.				
6)	Terminal block cover	Covers for preventing electric shock while the power is on.				
	Terminal block for analog output signals	A 2-piece screw terminal block for connecting to the external device.				
7)	SET/SEL button	Select the setting target by pressing the ▲ button or ▼ button in the offset/gain setting mode.				
8)	+/- button	Select the analog output value by pressing the + button or - button in the offset/gain setting mode.				

(1) Module status and LED status

The following table lists the correspondence between the module status and the LED status.

Module status		Data link status	LED status						
			PW LED	RUN LED	MODE LED	D LINK LED	ERR. LED	ALM LED	O/G LED
Normal mode	Disconnecting	Disconnection	ON	ON	ON	OFF	OFF	OFF	OFF
	Link in progress	Data link in operation	ON	ON	ON	ON	OFF	OFF	OFF
	Reserved station specification in progress	Cyclic stop	ON	ON	ON	Flashing	OFF	OFF	OFF
	Link stop	Cyclic stop	ON	ON	ON	Flashing	OFF	OFF	OFF
Offset/gain setting mode		-	ON	OFF	OFF	OFF	OFF	OFF	ON
Unit test	In progress	-	ON	ON	Flashing	*1	OFF	OFF	OFF
	Normal completion	-	ON	ON	OFF	OFF	OFF	OFF	OFF
	Abnormal completion	-	ON	ON	OFF	OFF	ON	OFF	OFF
Communication error		Cyclic stop	ON	ON	ON	Flashing	ON	OFF	OFF
Error	Major error	-	ON	OFF	*2	*1	ON*3	*1	OFF
	Moderate error	-	ON	ON	*2	*1	ON	*1	OFF
Warning	Minor error	-	ON	ON	*2	*1	Flashing	*1	OFF
Alarm	Alert	-	ON	ON	ON	*1	*1	ON	OFF
	Out-of-range digital value error	-	ON	ON	ON	*1	*1	Flashing	OFF

*1 Either of ON, Flashing, or OFF.

*2 Either of ON or OFF.

*3 When the module is failed, the LED may not turn on.

CHAPTER 3 SPECIFICATIONS

This chapter describes the specifications of the D/A converter module.

3.1 General Specifications

Item	Specifications					
Operating ambient temperature	0 to 55°C					
Storage ambient temperature	-25 to 75°C					
Operating ambient humidity	5 to 95%RH, non-condensing					
Storage ambient humidity						
Vibration resistance	Compliant with JIS B 3502 and IEC 61131-2		Frequency	Constant acceleration	Half amplitude	Number of sweeps
		Under intermittent vibration	5 to 8.4Hz	-	3.5mm	10 times each in X, Y, and Z directions
			8.4 to 150Hz	9.8m/s ²	-	
		Under continuous vibration	5 to 8.4Hz	-	1.75mm	-
8.4 to 150Hz	4.9m/s ²		-			
Shock resistance	Compliant with JIS B 3502 and IEC 61131-2 (147m/s ² , 3 times each in X, Y, and Z directions)					
Operating atmosphere	No corrosive gases					
Operating altitude *1	0 to 2000m					
Installation location	Inside a control panel*2					
Overvoltage category *3	II or less					
Pollution degree *4	2 or less					
Equipment class	Class I					

- *1 Do not use or store the D/A converter module under pressure higher than the atmospheric pressure of altitude 0m. Doing so may cause malfunction. When using the D/A converter module under pressure, please consult your local Mitsubishi representative.
- *2 If the environment satisfies the operating ambient temperature, operating ambient humidity and other conditions, the module can be used even outside the control panel.
- *3 This indicates the section of the power supply to which the equipment is assumed to be connected between the public electrical power distribution network and the machinery within premises. Category II applies to equipment for which electrical power is supplied from fixed facilities. The surge voltage withstand level for the equipment with the rated voltage of 300V or less is 2500V.
- *4 This index indicates the degree to which conductive material is generated in terms of the environment in which the equipment is used. Pollution degree 2 is when only non-conductive pollution occurs. A temporary conductivity caused by condensing must be expected occasionally.

Point 

To use the D/A converter module complying with the EMC Directive, refer to "EMC and Low Voltage Directives" in this manual. ( Page 156, Appendix 7)

3.2 Performance Specifications

Item		Description																								
Number of analog output points		4 points (4 channels)/module																								
Digital input		16-bit signed binary (-16384 to 16383, -288 to 12287, -12288 to 12287)																								
Analog output	Voltage	-10 to 10VDC (external load resistance value: 1kΩ to 1MΩ)																								
	Current	0 to 20mADC (external load resistance value: 0Ω to 600Ω)																								
I/O characteristics, maximum resolution ^{*1}		<table border="1"> <thead> <tr> <th>Output</th> <th>Output range</th> <th>Digital value</th> <th>Maximum resolution</th> </tr> </thead> <tbody> <tr> <td rowspan="4">Voltage</td> <td>-10 to 10V</td> <td>-16000 to 16000</td> <td>0.625mV</td> </tr> <tr> <td>0 to 5V</td> <td rowspan="2">0 to 12000</td> <td>0.416mV</td> </tr> <tr> <td>1 to 5V</td> <td>0.333mV</td> </tr> <tr> <td>User range setting 1 (-10 to 10V)</td> <td>-12000 to 12000</td> <td>0.333mV</td> </tr> <tr> <td rowspan="3">Current</td> <td>0 to 20mA</td> <td rowspan="3">0 to 12000</td> <td>1.66μA</td> </tr> <tr> <td>4 to 20mA</td> <td>1.33μA</td> </tr> <tr> <td>User range setting 2 (0 to 20mA)</td> <td>0.95μA</td> </tr> </tbody> </table>	Output	Output range	Digital value	Maximum resolution	Voltage	-10 to 10V	-16000 to 16000	0.625mV	0 to 5V	0 to 12000	0.416mV	1 to 5V	0.333mV	User range setting 1 (-10 to 10V)	-12000 to 12000	0.333mV	Current	0 to 20mA	0 to 12000	1.66μA	4 to 20mA	1.33μA	User range setting 2 (0 to 20mA)	0.95μA
		Output	Output range	Digital value	Maximum resolution																					
		Voltage	-10 to 10V	-16000 to 16000	0.625mV																					
			0 to 5V	0 to 12000	0.416mV																					
			1 to 5V		0.333mV																					
			User range setting 1 (-10 to 10V)	-12000 to 12000	0.333mV																					
		Current	0 to 20mA	0 to 12000	1.66μA																					
			4 to 20mA		1.33μA																					
			User range setting 2 (0 to 20mA)		0.95μA																					
		Conversion accuracy ^{*2}	Ambient temperature (25±5°C)	±0.2%																						
Ambient temperature (0 to 55°C)	±0.3%																									
Conversion speed		100μs/channel																								
Output short protection		Protected																								
Absolute maximum output		Voltage: ±15V, Current: ±21mA																								
Insulation method		Between communication system terminal and all analog output terminals: Photocoupler isolation Between power supply system terminal and all analog output terminals: Transformer insulation Between output channels: Non-insulation																								
Withstand voltage		500VAC for 1 minute between all power supply and communication system terminals and all analog output terminals																								
Noise immunity		Noise voltage 500Vp-p, noise width 1μs, noise frequency 25 to 60Hz (noise simulator condition)																								
External connection system	Communication part	RJ45 connector																								
	Module power supply part	Terminal block for module power supply and FG Tightening torque range for terminal screw (M2.5 screw): 0.5 to 0.6N·m																								
	I/O part	18-point two-piece terminal block (M3 screw) Tightening torque range for terminal screw (M3 screw × 5.2): 0.43 to 0.57N·m																								
Applicable DIN rail		TH35-7.5Fe, TH35-7.5Al (compliant with IEC 60715)																								
Applicable wire size	For power supply	Core: 0.5 to 1.5mm ² (20 to 16 AWG)																								
	For I/O	Core: 0.3 to 2.0mm ² (22 to 14 AWG)																								

Item		Description
Applicable solderless terminal	Terminal block for module power supply and FG*3	TE 0.5-10 (Nichifu Co. Ltd.) [Applicable wire size: 0.5mm ²] TE 0.75-10 (Nichifu Co. Ltd.) [Applicable wire size: 0.75mm ²] TE 1.0-10 (Nichifu Co. Ltd.) [Applicable wire size: 0.9 to 1.0mm ²] TE 1.5-10 (Nichifu Co. Ltd.) [Applicable wire size: 1.25 to 1.5mm ²] AI 0.34-12TQ (Phoenix Contact Co. Ltd.) [Applicable wire size: 0.34mm ²] AI 0.5-10WH (Phoenix Contact Co. Ltd.) [Applicable wire size: 0.5mm ²] AI 0.75-10GY (Phoenix Contact Co. Ltd.) [Applicable wire size: 0.75mm ²] AI 1-10RD (Phoenix Contact Co. Ltd.) [Applicable wire size: 1.0mm ²] AI 1.5-10BK (Phoenix Contact Co. Ltd.) [Applicable wire size: 1.5mm ²]
	Terminal block for analog output signals	RAV1.25-3 (compliant with JIS C 2805) [Applicable wire size: 0.3 to 1.25mm ²] V2-MS3 (JST Mfg. Co., Ltd) [Applicable wire size: 1.25 to 2.0mm ²] RAP2-3SL (Nippon Tanshi Co., Ltd.) [Applicable wire size: 1.25 to 2.0mm ²] TGV2-3N (Nichifu Co., Ltd.) [Applicable wire size: 1.25 to 2.0mm ²]
Station type		Remote device station
Cyclic transmission	RX/Ry points	32 points + 16 points × number of extension modules
	RWr/RWw points	16 points + points of each extension module
Communication cable		An Ethernet cable that meets the 1000BASE-T standard: Category 5e or higher (double shielded, STP), straight cable
Availability of connecting extension module		Connectable (Max. one module)
External power supply		24VDC (20.4 to 28.8VDC) Inrush current: 30.1A, 1.5ms or less Current consumption: 325mA
Weight		0.30kg

- *1 For details on the I/O conversion characteristics, refer to the following.
• I/O Conversion Characteristic of D/A Conversion (📄 Page 152, Appendix 4)
- *2 Except when receiving noise influence.
- *3 Do not connect two or more wires to the terminal.

3.3 Calculating Current Consumption

The total current consumption of the modules is calculated by summing the module power supply current in the main module and extension module.

The power supply current in the extension module should be within 30mA.

For the value of the module power supply current, refer to the specifications of each module.

- Performance Specifications of D/A converter module (☞ Page 25, Section 3.2)
- Performance Specifications of extension I/O module (📖 CC-Link IE Field Network Remote I/O Module User's Manual)

The value of the module power supply current in the extension module described in the specifications is the value of the module power supply current supplied from the main module.

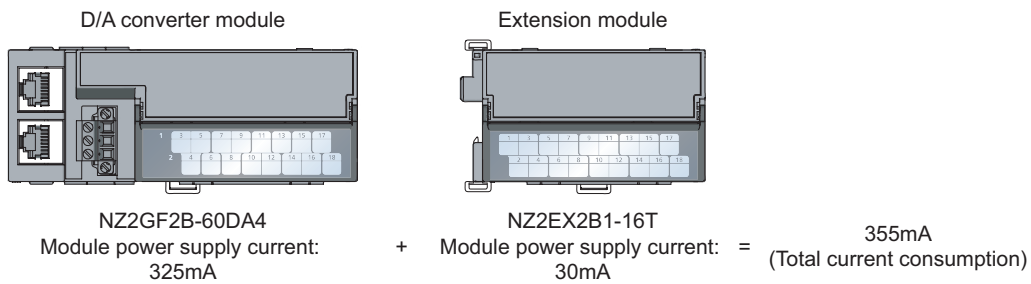

3.4 Function List

Item	Description	Reference
D/A conversion enable/disable function	Whether to enable or disable D/A conversion can be set for each channel. Disabling the D/A conversion for unused channels reduces the conversion cycles.	Page 74, Section 8.1
D/A output enable/disable function	Whether to output the D/A conversion value or the offset value can be set for each channel. The conversion speed is constant, regardless of the output enable/disable status.	Page 74, Section 8.2
Range switching function	The output range can be selected for each channel from the following ranges: <ul style="list-style-type: none"> • Factory default range (4 to 20mA, 0 to 20mA, 1 to 5V, 0 to 5V, -10 to 10V) • User range (user range setting 1, user range setting 2) 	Page 75, Section 8.3
Offset/gain setting function	This function compensates for errors in analog output values.	Page 72, Section 7.3
Analog output HOLD/CLEAR function	Whether to hold or clear the output analog value can be set, according to the CPU module operating status (RUN, STOP, or stop error).	Page 76, Section 8.4
Cyclic data update watch function	The update intervals of cyclic data are monitored. The last output value is held or cleared when the cyclic transmission stop status continues longer than the set monitoring time.	Page 78, Section 8.5
Scaling function	The D/A converter module scale-converts the digital value to the set range of the scaling upper limit value and scaling lower limit value. The programming for scale conversion can be reduced.	Page 79, Section 8.6
Shift function	Using this function, the D/A converter module outputs the converted digital value with the shifting set value added, in analog. Fine adjustment can be performed easily when the system starts.	Page 85, Section 8.7
Digital value range check function	An error is output when the digital value is out of the digital input range for the output range.	Page 89, Section 8.8
Alert output function	This function outputs alert when a digital value is in the range set in advance.	Page 92, Section 8.9
Error notification function	When a moderate error or major error occurs in the D/A converter module, this function notifies the master station of the error with the remote input signal.	Page 95, Section 8.10
Function at the extension module installation	One extension I/O module can be connected to one D/A converter module. Remote input signals of the D/A converter module can be assigned to remote output signals of the connected extension output module. In addition, functions unique to the extension I/O module can be used.	Page 98, Section 8.11
CC-Link IE Field Network diagnostic function	With this function, whether any network error occurs or not can be checked through GX Works2 connected to the CPU module.	Page 102, Section 8.12

3.5 List of Remote I/O Signals

This section lists I/O signals for a master/local module.

The device numbers shown are the example with the remote I/O signals of the main module assigned to the I/O numbers of RX0 to RX1F and RY0 to RY1F.

Remote input (RX) indicates the input signal from the D/A converter module to the master/local module.

Remote output (RY) indicates the output signal from the master/local module to the D/A converter module.

The remote I/O signals of the main module and extension module are assigned as shown below.

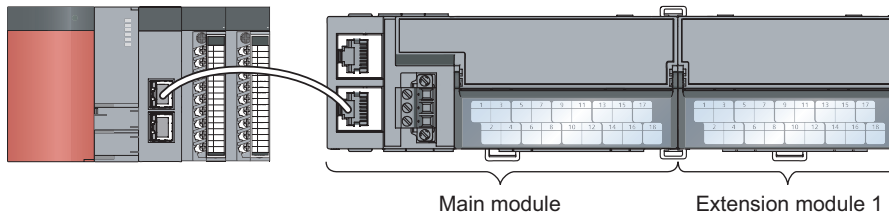

Module	Remote input (RX)	Remote output (RY)
Main module	RX0 to RX1F	RY0 to RY1F
Extension module 1	RX20 to RX2F	RY20 to RY2F

For details on the remote I/O signal, refer to the following.

- Page 131, Appendix 1

Module type	Remote input signal direction: D/A converter module → Master/local module		Remote output signal direction: Master/local module → D/A converter module	
	Device number	Description	Device number	Description
Main module	RX0	Use prohibited	RY0	Use prohibited
	RX1	Use prohibited	RY1	Use prohibited
	RX2	Use prohibited	RY2	Use prohibited
	RX3	Use prohibited	RY3	Use prohibited
	RX4	Use prohibited	RY4	Use prohibited
	RX5	Use prohibited	RY5	Use prohibited
	RX6	Use prohibited	RY6	Use prohibited
	RX7	Warning flag	RY7	Use prohibited
	RX8	Use prohibited	RY8	Use prohibited
	RX9	Initial data setting completed flag	RY9	Initial data setting request flag
	RXA	Error flag	RYA	Error clear request flag
	RXB	Remote READY	RYB	Use prohibited
	RXC	Use prohibited	RYC	Use prohibited
	RXD	Use prohibited	RYD	Use prohibited
	RXE	Use prohibited	RYE	Use prohibited
	RXF	Use prohibited	RYF	Use prohibited

Module type	Remote input signal direction: D/A converter module → Master/local module		Remote output signal direction: Master/local module → D/A converter module	
	Device number	Description	Device number	Description
Main module	RX10	Use prohibited	RY10	CH1 Output enable/disable flag
	RX11	Use prohibited	RY11	CH2 Output enable/disable flag
	RX12	Use prohibited	RY12	CH3 Output enable/disable flag
	RX13	Use prohibited	RY13	CH4 Output enable/disable flag
	RX14	Use prohibited	RY14	Use prohibited
	RX15	Use prohibited	RY15	Use prohibited
	RX16	Use prohibited	RY16	Use prohibited
	RX17	Use prohibited	RY17	Use prohibited
	RX18	Use prohibited	RY18	Use prohibited
	RX19	Use prohibited	RY19	Use prohibited
	RX1A	Use prohibited	RY1A	Use prohibited
	RX1B	Use prohibited	RY1B	Use prohibited
	RX1C	Use prohibited	RY1C	Use prohibited
	RX1D	Use prohibited	RY1D	Use prohibited
	RX1E	Alert output signal	RY1E	Alert output clear request flag
RX1F	External power supply monitor state flag (for extension output module)	RY1F	External power supply monitor request flag (for extension output module)	
Extension module 1	RX20 to RX2F	Remote input (RX) of the connected extension module is assigned.	RY20 to RY2F	Remote output (RY) of the connected extension module is assigned.



Do not use any "Use prohibited" remote I/O signals. If any of the signals are used, correct operation of the module cannot be guaranteed.

(1) Remote I/O signal of the extension module

The remote I/O signal differs depending on the model of the extension module.

- Extension I/O module

Refer to the following.

CC-Link IE Field Network Remote I/O Module User's Manual

3.6 List of Remote Register

This section lists remote registers for a master/local module.

The remote registers shown are the example with the remote registers of the main module assigned to the remote registers of RWr0 to RWrF and RWw0 to RWwF.

Remote register (RWr) is the information input from the D/A converter module to the master/local module.

Remote register (RWw) is the information output from the master/local module to the D/A converter module.

For details on the remote register, refer to the following.

-  Page 136, Appendix 2

Remote register (RWr) signal direction: D/A converter module → Master/local module		Remote register (RWw) signal direction: Master/local module → D/A converter module	
Device number	Description	Device number	Description
RWr0	Latest error code	RWw0	Use prohibited
RWr1	Latest warning code	RWw1	Use prohibited
RWr2	CH1 Set value check code	RWw2	CH1 Digital value
RWr3	CH2 Set value check code	RWw3	CH2 Digital value
RWr4	CH3 Set value check code	RWw4	CH3 Digital value
RWr5	CH4 Set value check code	RWw5	CH4 Digital value
RWr6	Use prohibited	RWw6	CH1 Shifting set value
RWr7	Use prohibited	RWw7	CH2 Shifting set value
RWr8	Use prohibited	RWw8	CH3 Shifting set value
RWr9	Use prohibited	RWw9	CH4 Shifting set value
RWrA	Alert output flag	RWwA	Use prohibited
RWrB	Use prohibited	RWwB	Use prohibited
RWrC	Use prohibited	RWwC	Use prohibited
RWrD	Use prohibited	RWwD	Use prohibited
RWrE	Use prohibited	RWwE	Use prohibited
RWrF	Use prohibited	RWwF	Use prohibited

Point

Do not read or write the data to/from any "Use prohibited" remote registers. If the data is read or written from/to any of the registers, correct operation of the module cannot be guaranteed.

3.7 List of Remote Buffer Memory

This section lists the remote buffer memory areas of the D/A converter module.

The remote buffer memory areas of the main module and extension module are assigned as shown below.

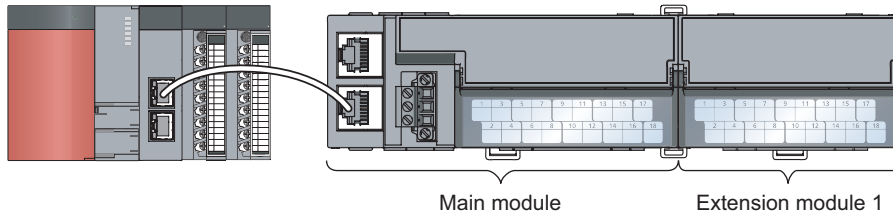

Ex. Example of the remote buffer memory in the manual



For details on the remote buffer memory for the D/A converter module, refer to the following.

- Page 140, Appendix 3

For details on the remote buffer memory of the connected extension module, refer to the following.

- User's manual for the connected extension module

○: Available, ×: Unavailable

Buffer memory address		Area	Target	Access method		
Decimal	Hexadecimal			CC IE Field configuration of GX Works2	REMFR instruction, REMTO instruction*1	
0 to 255	0000 _H to 00FF _H	Parameter area	Station-based parameter data		○*2	○
256 to 511	0100 _H to 01FF _H		Module-based parameter data	Main module		
512 to 767	0200 _H to 02FF _H			Extension module 1		
768 to 1279	0300 _H to 04FF _H			System area		
1280 to 1535	0500 _H to 05FF _H	Monitoring area	Station-based monitoring data		×	○
1536 to 1791	0600 _H to 06FF _H		Module-based monitoring data	Main module		
1792 to 2047	0700 _H to 07FF _H			Extension module 1		
2048 to 2559	0800 _H to 09FF _H			System area		
2560 to 4095	0A00 _H to 0FFF _H	Error history area	Station-based error history data		○*2	○
4096 to 4351	1000 _H to 10FF _H	Module control data area	Station-based control data		×	○
4352 to 4607	1100 _H to 11FF _H		Module-based control data	Main module		
4608 to 4863	1200 _H to 12FF _H			Extension module 1		
4864 to 5375	1300 _H to 14FF _H			System area		

*1 For the REMFR and REMTO instructions, refer to the following.

 User's manual for the master/local module used

*2 For the access method, refer to the following.

• Parameter area ( Page 63, Section 7.1)

• Error history area ( Page 116, Section 11.1)

Point

Do not access the system area using the REMFR or REMTO instruction. Doing so may lead the module to malfunction.

3

(1) Parameter area (address: 0000_H to 04FF_H)

For the parameter area, parameters can be set using the CC IE Field configuration of GX Works2 or using the REMTO instruction.

The parameter in the parameter area is backed up to the nonvolatile memory.

The parameter backed up to the nonvolatile memory is read to the parameter area when the module power supply is turned off and on or the module returns from remote reset.

If the parameter is written from the parameter setting of the CC IE Field configuration of GX Works2, it is also written to the nonvolatile memory at that time. When the parameter is written using the REMTO instruction, it is written to the nonvolatile memory when Initial data setting request flag (RY9) is turned off and on. At this time, the parameter is written to the nonvolatile memory even though it is incorrect. When the power supply is turned off and on with an incorrect parameter written, the incorrect parameter is read from the nonvolatile memory and an error code is stored to Latest error code (RWr0). Take corrective action according to the error code list.

( Page 119, Section 11.2)

Type	Address		Description	Default ^{*1}	Read/Write ^{*2}
	Decimal	Hexadecimal			
Station-based parameter data	0 to 3	0000 _H to 0003 _H	System area	-	-
	4	0004 _H	Alert output signal assignment (for external signal assignment function)	FFFF _H	R/W
	5	0005 _H	Error flag assignment (for external signal assignment function)	FFFF _H	R/W
	6	0006 _H	Warning flag assignment (for external signal assignment function)	FFFF _H	R/W
	7	0007 _H	Cyclic data update watch time setting	0000 _H	R/W
	8 to 15	0008 _H to 000F _H	System area	-	-
	16	0010 _H	Input response time setting	0005 _H	R/W
	17	0011 _H	Digital output HOLD/CLEAR setting	0000 _H	R/W
	18 to 255	0012 _H to 00FF _H	System area	-	-

Type	Address		Description	Default *1	Read/Write *2
	Decimal	Hexadecimal			
Module-based parameter data (main module)	256, 257	0100 _H , 0101 _H	System area	-	-
	258	0102 _H	D/A conversion enable/disable setting	000F _H	R/W
	259	0103 _H	Range setting	0000 _H	R/W
	260	0104 _H	Analog output HOLD/CLEAR setting	0000 _H	R/W
	261	0105 _H	Alert output setting	000F _H	R/W
	262	0106 _H	CH1 Alert output upper limit value	0000 _H	R/W
	263	0107 _H	CH1 Alert output lower limit value	0000 _H	R/W
	264	0108 _H	CH2 Alert output upper limit value	0000 _H	R/W
	265	0109 _H	CH2 Alert output lower limit value	0000 _H	R/W
	266	010A _H	CH3 Alert output upper limit value	0000 _H	R/W
	267	010B _H	CH3 Alert output lower limit value	0000 _H	R/W
	268	010C _H	CH4 Alert output upper limit value	0000 _H	R/W
	269	010D _H	CH4 Alert output lower limit value	0000 _H	R/W
Module-based parameter data (main module)	270	010E _H	Scaling enable/disable setting	000F _H	R/W
	271	010F _H	CH1 Scaling lower limit value	0	R/W
	272	0110 _H	CH1 Scaling upper limit value	0	R/W
	273	0111 _H	CH2 Scaling lower limit value	0	R/W
	274	0112 _H	CH2 Scaling upper limit value	0	R/W
	275	0113 _H	CH3 Scaling lower limit value	0	R/W
	276	0114 _H	CH3 Scaling upper limit value	0	R/W
	277	0115 _H	CH4 Scaling lower limit value	0	R/W
	278	0116 _H	CH4 Scaling upper limit value	0	R/W
	279 to 511	0117 _H to 01FF _H	System area	-	-
Module-based parameter data (extension module 1)	512 to 767	0200 _H to 02FF _H	The remote buffer memory of the connected extension module is assigned.	-	-
-	768 to 1279	0300 _H to 04FF _H	System area	-	-

*1 This is the value at default or initialization by Parameter area initialization command (address: 1002_H).

*2 This shows whether read or write from programs is possible.

R: Readable

W: Writable

(a) Parameter area of the extension module

The remote buffer memory differs depending on the model of the extension module.

- Extension input module (NZ2EX2B1-16D)

Address		Description	Default ^{*1}	Read/Write ^{*2}
Decimal	Hexadecimal			
512	0200 _H	Extension module identification code	0000 _H	R/W
513 to 767	0201 _H to 02FF _H	System area	-	-

*1 This is the value at default or initialization by Parameter area initialization command (address: 1002_H).

*2 This shows whether read or write from programs is possible.

R: Readable

W: Writable

- Extension output module (NZ2EX2B1-16T)

Address		Description	Default ^{*1}	Read/Write ^{*2}
Decimal	Hexadecimal			
512	0200 _H	Extension module identification code	0000 _H	R/W
513	0201 _H	System area	-	-
514	0202 _H	Number of ON times integration function enable Y0 to YF	0000 _H	R/W
515 to 591	0203 _H to 02FF _H	System area	-	-

*1 This is the value at default or initialization by Parameter area initialization command (address: 1002_H).

*2 This shows whether read or write from programs is possible.

R: Readable

W: Writable

(2) Monitoring area (address: 0500_H to 09FF_H)

Type	Address		Description	Default ^{*1}	Read/Write ^{*2}
	Decimal	Hexadecimal			
Station-based monitoring data	1280 to 1535	0500 _H to 05FF _H	System area	-	-
Module-based monitoring data (main module)	1536 to 1791	0600 _H to 06FF _H	System area	-	-
Module-based monitoring data (extension module 1)	1792 to 2047	0700 _H to 07FF _H	The remote buffer memory of the connected extension module is assigned.	-	-
-	2048 to 2559	0800 _H to 09FF _H	System area	-	-

*1 This is the value for when the module power supply is turned off and on or at the remote reset.

*2 This shows whether read or write from programs is possible.

R: Readable

W: Writable

(a) Monitoring area of the extension module

The remote buffer memory differs depending on the model of the extension module.

- Extension input module (NZ2EX2B1-16D)

	Address		Description	Default ^{*1}	Read/Write ^{*2}
	Decimal	Hexadecimal			
1792	0700 _H		Extension module identification code	0000 _H	R
1793 to 2047	0701 _H to 07FF _H		System area	-	-

*1 This is the value for when the module power supply is turned off and on or at the remote reset.

*2 This shows whether read or write from programs is possible.

R: Readable

W: Writable

- Extension output module (NZ2EX2B1-16T)

	Address		Description	Default ^{*1}	Read/Write ^{*2}
	Decimal	Hexadecimal			
1792	0700 _H		Extension module identification code	0000 _H	R
1793 to 1807	0701 _H to 070F _H		System area	-	-
1808 to 1809	0710 _H to 0711 _H		Number of ON times integration value Y0	0	R
1810 to 1811	0712 _H to 0713 _H		Number of ON times integration value Y1	0	R

Address		Description	Default *1	Read/Write *2
Decimal	Hexadecimal			
1812 to 1813	0714 _H to 0715 _H	Number of ON times integration value Y2	0	R
1814 to 1815	0716 _H to 0717 _H	Number of ON times integration value Y3	0	R
1816 to 1817	0718 _H to 0719 _H	Number of ON times integration value Y4	0	R
1818 to 1819	071A _H to 071B _H	Number of ON times integration value Y5	0	R
1820 to 1821	071C _H to 071D _H	Number of ON times integration value Y6	0	R
1822 to 1823	071E _H to 071F _H	Number of ON times integration value Y7	0	R
1824 to 1825	0720 _H to 0721 _H	Number of ON times integration value Y8	0	R
1826 to 1827	0722 _H to 0723 _H	Number of ON times integration value Y9	0	R
1828 to 1829	0724 _H to 0725 _H	Number of ON times integration value YA	0	R
1830 to 1831	0726 _H to 0727 _H	Number of ON times integration value YB	0	R
1832 to 1833	0728 _H to 0729 _H	Number of ON times integration value YC	0	R
1834 to 1835	072A _H to 072B _H	Number of ON times integration value YD	0	R
1836 to 1837	072C _H to 072D _H	Number of ON times integration value YE	0	R
1838 to 1839	072E to 072F	Number of ON times integration value YF	0	R
1840 to 2047	0730 _H to 07FF _H	System area	-	-

*1 This is the value for when the module power supply is turned off and on or at the remote reset.

*2 This shows whether read or write from programs is possible.

R: Readable

W: Writable

(3) Error history area (address: 0A00_H to 0FFF_H)

Type	Address		Description	Default ^{*1}	Read/Write ^{*2}	
	Decimal	Hexadecimal				
Station-based error history data	2560	0A00 _H	Error history 1	Error code	0000 _H	R
	2561	0A01 _H		Order of generation	0000 _H	R
	2562	0A02 _H		[Error time] First two digits of the year/Last two digits of the year	0000 _H	R
	2563	0A03 _H		[Error time] Month/Day	0000 _H	R
	2564	0A04 _H		[Error time] Hour/Minute	0000 _H	R
	2565	0A05 _H		[Error time] Second/00 _H (Fixed)	0000 _H	R
	2566	0A06 _H		CH1 Digital value	0000 _H	R
	2567	0A07 _H		CH2 Digital value	0000 _H	R
	2568	0A08 _H		CH3 Digital value	0000 _H	R
	2569	0A09 _H		CH4 Digital value	0000 _H	R
	2570 to 2575	0A0A _H to 0A0F _H			System area	-
	2576 to 2591	0A10 _H to 0A1F _H	Error history 2	Same as Error history 1.		
	2592 to 2607	0A20 _H to 0A2F _H	Error history 3	Same as Error history 1.		
	2608 to 2623	0A30 _H to 0A3F _H	Error history 4	Same as Error history 1.		
	2624 to 2639	0A40 _H to 0A4F _H	Error history 5	Same as Error history 1.		
	2640 to 2655	0A50 _H to 0A5F _H	Error history 6	Same as Error history 1.		
	2656 to 2671	0A60 _H to 0A6F _H	Error history 7	Same as Error history 1.		
	2672 to 2687	0A70 _H to 0A7F _H	Error history 8	Same as Error history 1.		
	2688 to 2703	0A80 _H to 0A8F _H	Error history 9	Same as Error history 1.		
	2704 to 2719	0A90 _H to 0A9F _H	Error history 10	Same as Error history 1.		
2720 to 2735	0AA0 _H to 0AAF _H	Error history 11	Same as Error history 1.			

Type	Address		Description	Default ^{*1}	Read/Write ^{*2}
	Decimal	Hexadecimal			
Station-based error history data	2736 to 2751	0AB0 _H to 0ABF _H	Error history 12	Same as Error history 1.	
	2752 to 2767	0AC0 _H to 0ACF _H	Error history 13		
	2768 to 2783	0AD0 _H to 0ADF _H	Error history 14		
	2784 to 2799	0AE0 _H to 0AEF _H	Error history 15		
	2800 to 4095	0AF0 _H to 0FFF _H	System area		

*1 This is the value at default or initialization by Error history clear command (address: 1000_H).

*2 This shows whether read or write from programs is possible.

R: Readable

W: Writable

(4) Module control data area (address: 1000_H to 14FF_H)

Type	Address		Description	Default ^{*1}	Read/Write ^{*2}
	Decimal	Hexadecimal			
Station-based control data	4096	1000 _H	Error history clear command	0	R/W
	4097	1001 _H	Error history clear completed	0	R
	4098	1002 _H	Parameter area initialization command	0	R/W
	4099	1003 _H	Parameter area initialization completed	0	R
	4100	1004 _H	Module operation information initialization command	0	R/W
	4101	1005 _H	Module operation information initialization completed	0	R
	4102 to 4351	1006 _H to 10FF _H	System area	-	-
Module-based control data (main module)	4352 to 4607	1100 _H to 11FF _H	System area	-	-
Module-based control data (extension module 1)	4608 to 4863	1200 _H to 12FF _H	The remote buffer memory of the connected extension module is assigned.	-	-
-	4864 to 5375	1300 _H to 14FF _H	System area	-	-

*1 This is the value for when the module power supply is turned off and on or at the remote reset.

*2 This shows whether read or write from programs is possible.

R: Readable

W: Writable

(a) Module control data area of the extension module

The remote buffer memory differs depending on the model of the extension module.

- Extension input module

Address		Description	Default ^{*1}	Read/Write ^{*2}
Decimal	Hexadecimal			
4608 to 4863	1200 _H to 12FF _H	System area	-	-

*1 This is the value for when the module power supply is turned off and on or at the remote reset.

*2 This shows whether read or write from programs is possible.

R: Readable

W: Writable

- Extension output module

Address		Description	Default ^{*1}	Read/Write ^{*2}
Decimal	Hexadecimal			
4608	1200 _H	Number of ON times integration value clear Y0 to YF	0000 _H	R/W
4609	1201 _H	Number of ON times integration value clear completed Y0 to YF	0000 _H	R
4610 to 4863	1202 _H to 12FF _H	System area	-	-

*1 This is the value for when the module power supply is turned off and on or at the remote reset.

*2 This shows whether read or write from programs is possible.

R: Readable

W: Writable

CHAPTER 4 THE PROCEDURE BEFORE OPERATION

This section describes the procedure before operation.

Check box

Setting a station number

Set the station number for an D/A converter module.

 Page 45, Section 6.1



Connection

When using an extension module, connect the extension module to the D/A converter module.
After that, mount the D/A converter module to a DIN rail.

 Page 46, Section 6.2,
Page 48, Section 6.3



Wiring

Connect the D/A converter module to a power supply, Ethernet cables, and external devices.

 Page 52, Section 6.4,
Page 54, Section 6.5,
Page 57, Section 6.6



Parameter settings and programming

Set parameters and create a program.

 Page 63, Section 7.1,
Page 68, Section 7.2.1*¹
Page 105, CHAPTER 9



Offset/gain setting

To use user range settings, configure the offset/gain setting.

 Page 72, Section 7.3

*1 To replace the module, refer to this section.

Point

To replace the module, follow the procedure described below.

- Power off the module and remove the D/A converter module.
- Prepare a new D/A converter module and perform the procedure above from "Setting a station number" to "Parameter settings and programming". (The network parameter of the master station does not need to be set again.)
- When using the user range setting, perform the offset/gain setting.
- After checking the operation, restart the control.

Memo

CHAPTER 5 SYSTEM CONFIGURATION

This chapter describes system configuration using a D/A converter module.
For CC-Link IE Field Network configuration, refer to the following.

 User's manual for the master/local module used

5.1 D/A Converter Module System Configuration

The following shows system configuration using a D/A converter module.

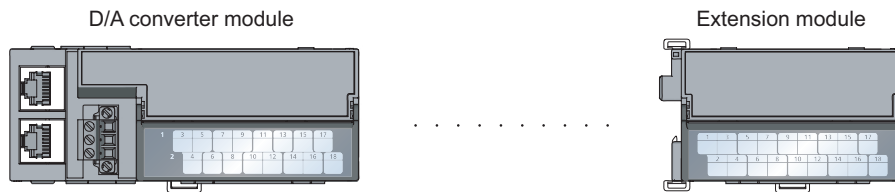

5.2 Applicable Systems

(1) Applicable master station

When using a D/A converter module, use the following products as a master station.

Model	First five digits of serial number
QJ71GF11-T2	"14102" or later
LJ71GF11-T2	

When a master station other than the above is used, the D/A converter module cannot be used.

(2) Connectable modules

One extension module can be connected to one D/A converter module.

Module	Model
Extension I/O module	NZ2EX2B1-16D
	NZ2EX2B1-16T

(3) Ethernet cable

For the specifications of the Ethernet cable, refer to the following.

 User's manual for the master/local module used

(4) Software package

GX Works2 is required for setting and diagnosing the D/A converter module.

Software	Version
GX Works2	Version 1.91V or later

CHAPTER 6 INSTALLATION AND WIRING

This chapter describes the installation and wiring of the D/A converter module.

6.1 Station Number Setting

(1) Setting procedure

Set the station number with the rotary switch on the front of the module. The setting value of the station number becomes valid when the module is powered on. Thus, set the station number when the module is powered off.

- The hundreds and tens places of the station number are set with x10.
- The ones place of the station number is set with x1.

Ex. To set the station number to 115, set the switch as shown below.

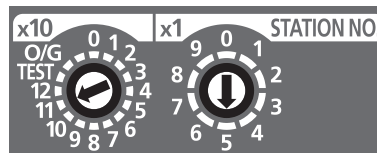

(2) Setting range

Set the station number from 1 to 120. Setting the value other than 1 to 120 causes a communication error and the D LINK LED flashes.

Point

- Changing the station number setting switch while the module is powered on causes a minor error and flashes the ERR. LED. Returning the station number setting switches to the previous setting eliminates the error after five seconds and turns off the ERR. LED.
- Do not set a station number duplicated with other station numbers. If the station number is duplicated, a communication error occurs and the D LINK LED does not turn on.

6.2 Installation Environment and Installation Position

6.2.1 Installation environment

(1) Installation location

Do not install the D/A converter module to the place where:

- Ambient temperature is outside the range of 0 to 55°C;
- Ambient humidity is outside the range of 5 to 95% RH;
- Condensation occurs due to rapid temperature change;
- Corrosive gas or combustible gas is present;
- Conductive powder such as dust and iron powder, oil mist, salinity, or organic solvent is filled;
- The D/A converter module is exposed to direct sunlight;
- A strong electric field or strong magnetic field is generated; and
- The D/A converter module is subject to vibration and shock.

(2) Installation surface

Install the D/A converter module on the flat surface. When the installation surface is uneven, excessive force is applied to the printed-circuit board and may cause a defect.

6.2.2 Installation position

When installing the D/A converter module in a control panel, provide clearance of 60mm or longer between the module and the sides of control panel or neighboring modules to ensure good ventilation and an easy module change.

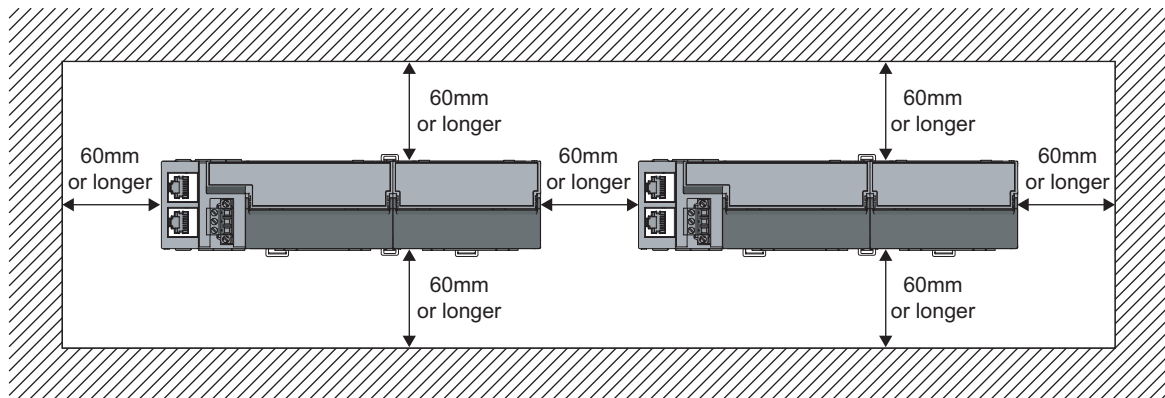

6.2.3 Installation direction

The D/A converter module can be installed in six directions. Use the DIN rail to install the module.

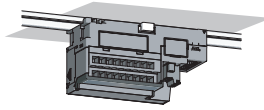

Downward installation

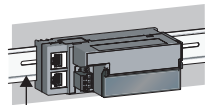

DIN rail

Horizontal installation

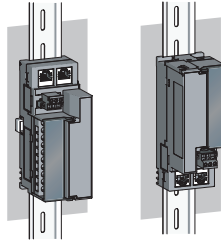

Vertical installation

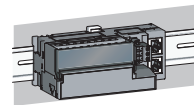

Horizontal installation
(upside down)

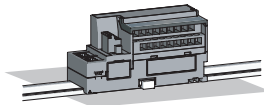

Upward installation

6.3 Installation

6.3.1 Connecting extension modules

(1) Connecting procedure

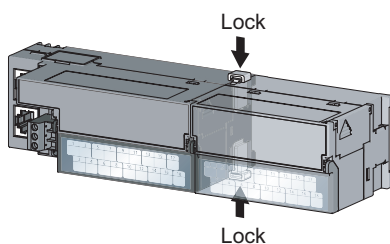
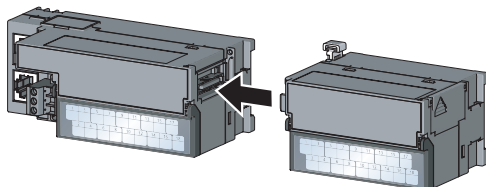
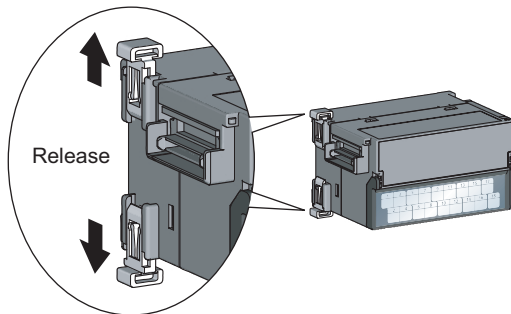
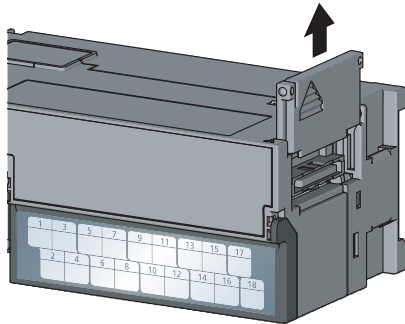

1. Remove the cover on the side of the module.
Do not dispose the removed cover, but store it.

2. Release the module joint levers (two points) on the side of the extension module. Slide the levers vertically.

3. Insert the connector of the extension module into that of the D/A converter module so that they are securely engaged.

4. Lock the module joint levers (two points) on the side of the extension module. Slide the levers toward the module.
Check that the modules are securely connected.

(2) Disconnecting procedure

Disconnect the modules by reversing the procedure above.

Point!

- Shut off the external power supply for the system in all phases before connecting or disconnecting extension modules.
 - Lock the module joint levers securely. Failure to do so may cause malfunction, failure, or drop of the module.
-

6.3.2 Mounting the modules on a DIN rail

Point

An example of the use of the DIN rail stopper is described in the following procedure. Fix the module according to the manual of the DIN rail stopper used.

(1) Mounting procedure

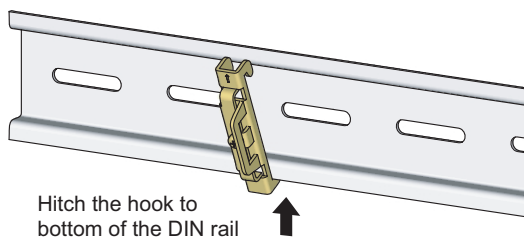
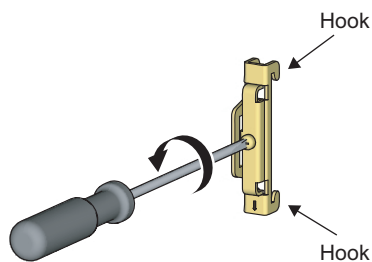
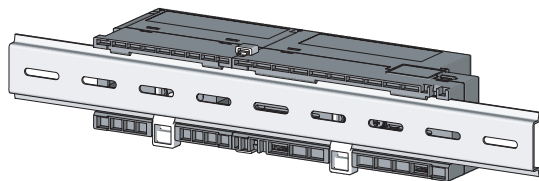
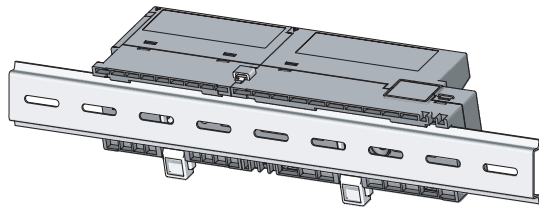
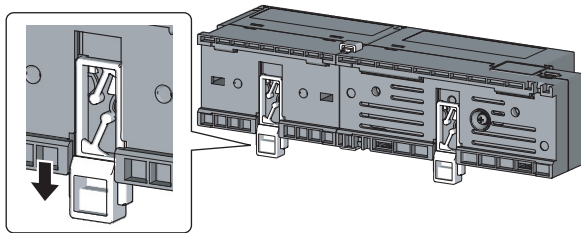

1. Pull down all DIN rail hooks on the back of the modules.
The levers should be pulled down until it clicks.
2. Hang the upper tabs of the modules on a DIN rail, and push the modules in position.
3. Lock the DIN rail hooks to the DIN rail to secure the modules in position.
Push each hook up until it clicks. If the hooks are beyond the reach, use a tool such as a screwdriver.
4. Loosen the screw on DIN rail stopper.
5. Hitch the bottom hook of the DIN rail stopper to the bottom of the DIN rail.
Hitch the hook according to the orientation of the arrow on the front of the stopper.

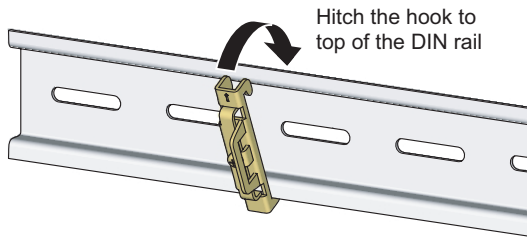

6. Hitch the upper hook of the DIN rail stopper to the top of the DIN rail.

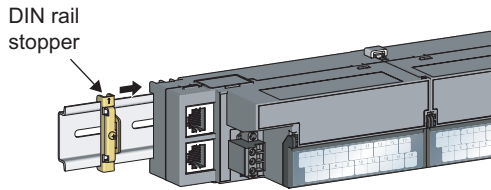

7. Slide the DIN rail stopper up to the left side of the modules.

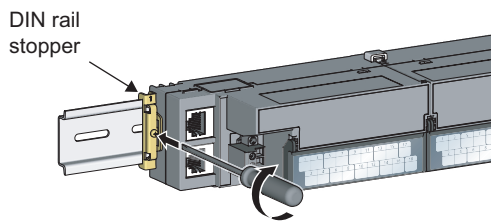

8. Hold the DIN rail stopper in the direction opposite to the arrow on the stopper and tighten the screw with a screwdriver.

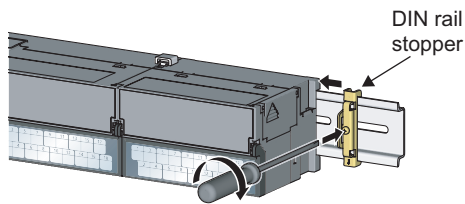

9. Install the DIN rail stopper on the right side of the module in the same procedure. Install the stopper upside down for the right side.

Point 

Do not slide modules from the edge of the DIN rail when mounting them. Doing so may damage the metal part located on the back of the module.

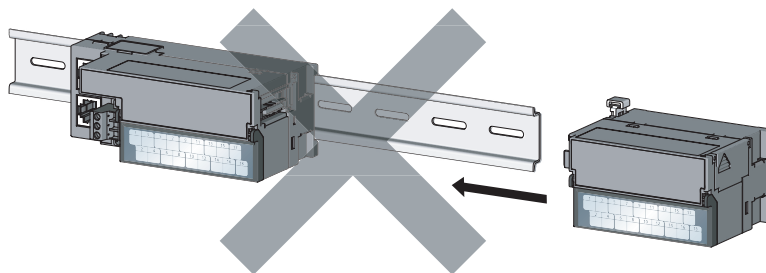

(2) Removal procedure

Remove the modules from the DIN rail by reversing the above procedure.

(3) Applicable DIN rail model (compliant with IEC 60715)

- TH35-7.5Fe
- TH35-7.5Al

(4) Interval between DIN rail mounting screws

Tighten the screws at intervals of 200mm or less.

(5) DIN rail stopper

Use a stopper that is attachable to the DIN rail.

6.4 Wiring with Terminal Block for Module Power Supply and FG

(1) Tightening torque

Tighten the terminal block screws within the following specified torque range.
Tightening the screws too much may damage the module case.

Screw type	Tightening torque range
Terminal block mounting screw (M2.5 screw)	0.2 to 0.3N•m
Terminal screw (M2.5 screw)	0.5 to 0.6N•m

(2) Wire to be used

The following table describes the wire to be connected to the terminal block for module power supply and FG.

Diameter	Type	Material	Temperature rating
22 to 16 AWG	Stranded	Copper	75°C or more

For applicable solderless terminals, refer to the following.

- Performance Specifications (☞ Page 25, Section 3.2)

(3) Installing and removing the terminal block

To remove the terminal block, loosen the terminal block fixing screw with a slotted screwdriver.

To install the terminal block, tighten the terminal block fixing screw.

Failure to secure the terminal block may cause drop, short circuit, malfunction.

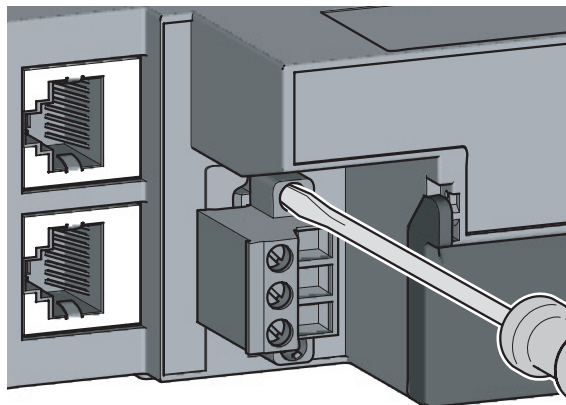

(4) Connecting and disconnecting the cable

To connect the cable, insert the wire with the cable fixing screw loosened and tighten the screw.

To disconnect the cable, pull out the wire with the cable fixing screw loosened with a slotted screwdriver.

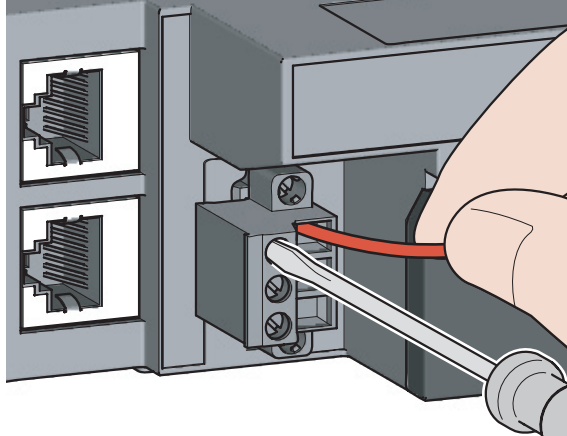

(5) Processing method of the cable terminal

Strip the cable about 10mm from the top.

To use a bar solderless terminal, connect it to the stripped part.

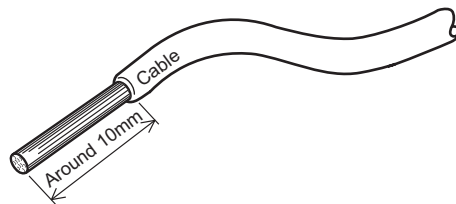

6.5 Wiring of Ethernet Cable

(1) Connecting the Ethernet cable

(a) Connecting

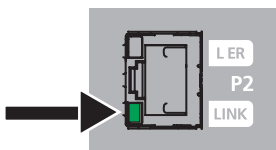
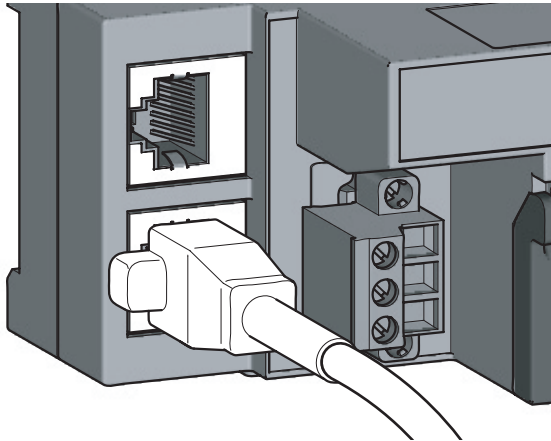

1. Power off the power supplies of the D/A converter module and the external device.
2. Push the Ethernet cable connector into the D/A converter module until it clicks. Pay attention to the connector's direction.
3. Power on the module.
4. Power on the external device.
5. Check if the LINK LED on the port into which the Ethernet cable is connected is on. The LINK LED may take a few seconds to turn on after power-on. If the LINK LED does not turn on, refer to the troubleshooting section and take a corrective action. (☞ Page 125, Section 11.4)

Point

- PORT1 and PORT2 need not to be distinguished. When only one connector is used in star topology, either PORT1 or PORT2 can be connected.

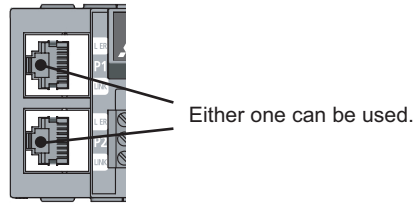

- When two connectors are used in line topology or ring topology, an Ethernet cable can be connected to the connectors in any combination. For example, the cable can be connected between PORT1s and between PORT1 and PORT2.

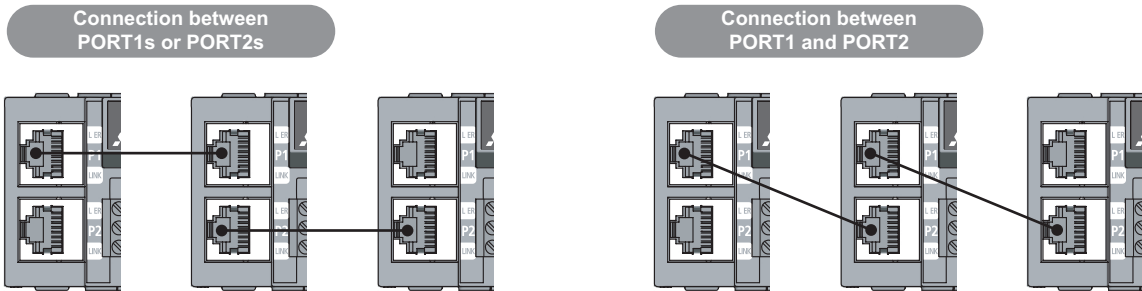

(b) Disconnecting

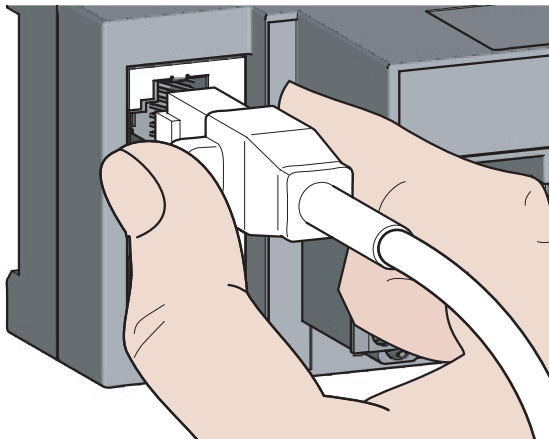

1. Power off the module.
2. Press the latch down and unplug the Ethernet cable.

(2) Precautions

(a) Laying Ethernet cables

- Place the Ethernet cable in a duct or clamp them. If not, dangling cable may swing or inadvertently be pulled, resulting in damage to the module or cables or malfunction due to poor contact.
- Do not touch the core of the connector of the cable or the module, and protect it from dirt and dust. If any oil from your hand, or any dirt or dust sticks to the core, it can increase transmission loss, causing data link to fail.
- Check the following:
 - Is any Ethernet cable disconnected?
 - Does any Ethernet cable short?
 - Are the connectors securely connected?

(b) Broken cable latch

Do not use Ethernet cables with broken latches. Doing so may cause the cable to unplug or malfunction.

(c) Connecting and disconnecting the Ethernet cable

Hold the connector part when connecting and disconnecting the Ethernet cable. Pulling the cable connected to the module may result in damage to the module or cable or malfunction due to poor contact.

(d) Connectors without Ethernet cable

To prevent dust from entering the module, attach the provided connector cover.

(e) Maximum station-to-station distance (Maximum Ethernet cable length)

The maximum station-to-station distance is 100m. However, the distance may be shorter depending on the operating environment of the cable. For details, contact the manufacturer of the cables used.

(f) Bending radius of the Ethernet cable

There are restrictions on the bending radius of the Ethernet cable. Check the bending radius in the specifications of the Ethernet cables used.

6.6 Wiring of External Device and Terminal Block

(1) Tightening torque

Tighten the terminal block screws within the following specified torque range.
Failure to secure the terminal block may cause malfunction, failure, or drop.

Screw type	Tightening torque range
Terminal screw (M3 screw)	0.43 to 0.57N•m
Terminal block mounting screw (M3.5 screw)	0.66 to 0.89N•m

The following table shows applicable solderless terminals connected to the terminal block. For wiring, use applicable wires in the following table and an appropriate tightening torque. Use UL-approved solderless terminals. For processing, use a tool recommended by manufacturers of solderless terminals. Sleeved solderless terminals cannot be used.

Solderless terminal		Wire			
Model	Applicable tightening torque	Diameter	Type	Material	Temperature rating
R1.25-3	0.43 to 0.57N•m	22 to 15 AWG	Stranded	Copper	75°C or more
V2-MS3					
RAP2-3SL					
TGV2-3N					

(2) Removing and installing the terminal block

(a) Removal procedure

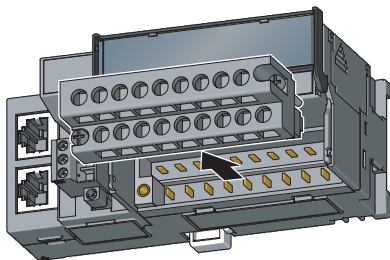
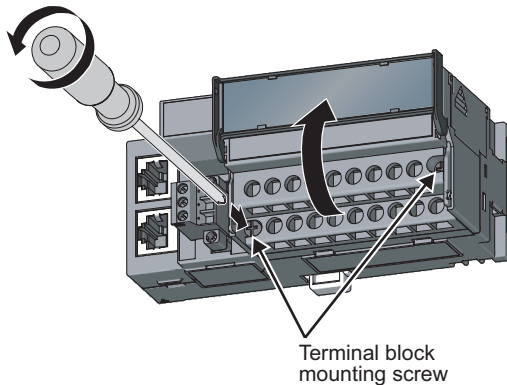

1. Open the terminal block cover and loosen the terminal block mounting screws (two points).
2. When the terminal block mounting screws (two points) are loosened, the 2-piece terminal block can be removed.

(b) Installation procedure

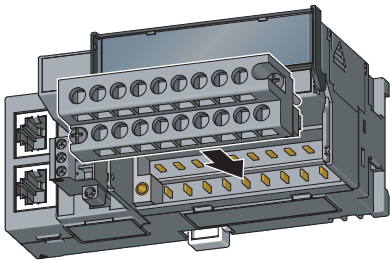

1. Open the terminal block cover to install the 2-piece terminal block.

2. Tighten the terminal block mounting screws.

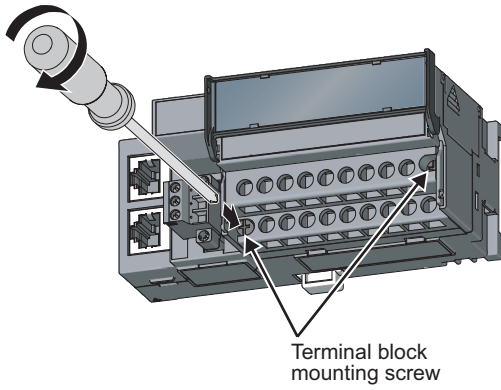

Terminal block
mounting screw

(3) Wiring of the external device and terminal block

(a) Signal name

The following shows signal names of the terminal block.

1	3	5	7	9	11	13	15	17
NC	CH1 V+	CH1 I+	CH2 V+	CH2 I+	CH3 V+	CH3 I+	CH4 V+	CH4 I+
2	4	6	8	10	12	14	16	18
NC	CH1 COM	NC	CH2 COM	NC	CH3 COM	NC	CH4 COM	NC

Pin number	Signal name	
1	NC	
2	NC	
3	CH1	V+
4		COM
5		I+
6	NC	
7	CH2	V+
8		COM
9		I+
10	NC	
11	CH3	V+
12		COM
13		I+
14	NC	
15	CH4	V+
16		COM
17		I+
18	NC	



Do not wire the NC terminals. Wrong wiring may cause the module to fail or malfunction.

(b) Wiring to a terminal block

The following shows wirings to a terminal block.

- For the voltage output

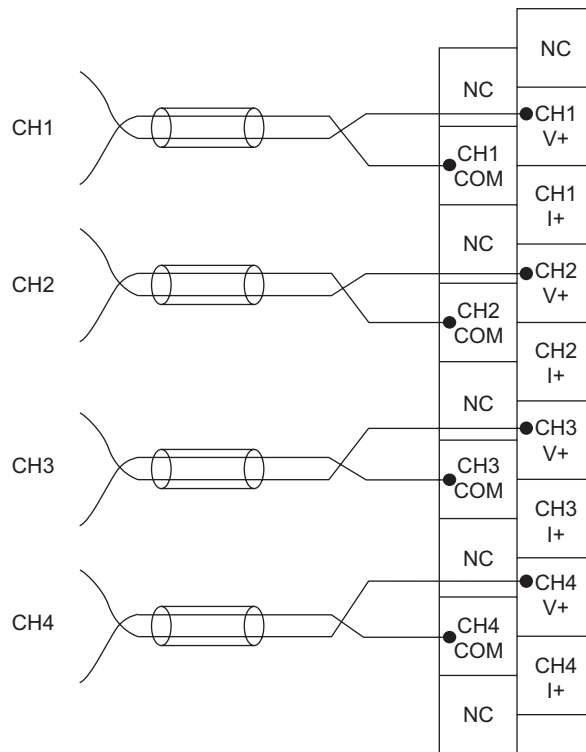

- For the current output

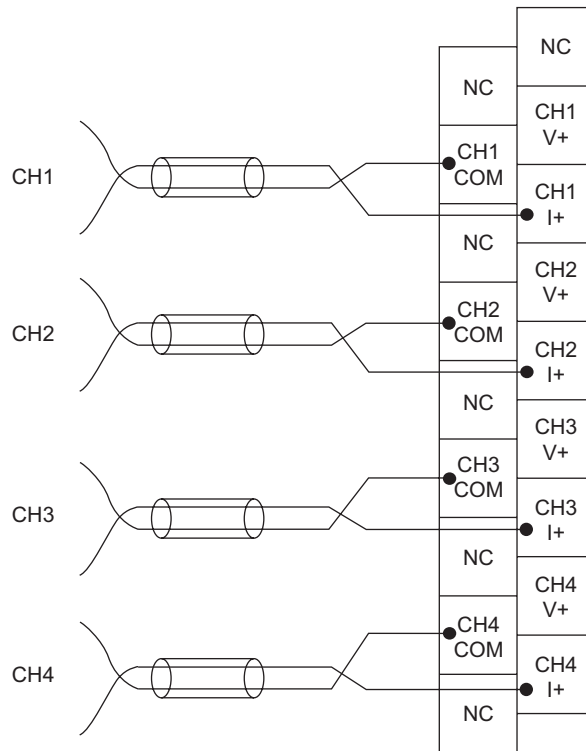

(c) Precautions for external wiring

To obtain the maximum performance from the functions of the D/A converter module and improve the system reliability, an external wiring with high durability against noise is required. Precautions for external wiring are as follows:

- Use separate cables for the AC control circuit and the external output signals of the D/A converter module to avoid the influence of the AC side surges or induction.
- Do not install cables together with the main circuit lines, high voltage lines, or power cables for equipment other than the programmable controller. Noise, surges, or induction may affect the system.
- Ground the shielded wires or shielded cables at one point on the programmable controller side. However, depending on the external noise conditions, it may be better to ground them externally.

(d) External wiring

The following describes the external wiring.

- For the voltage output

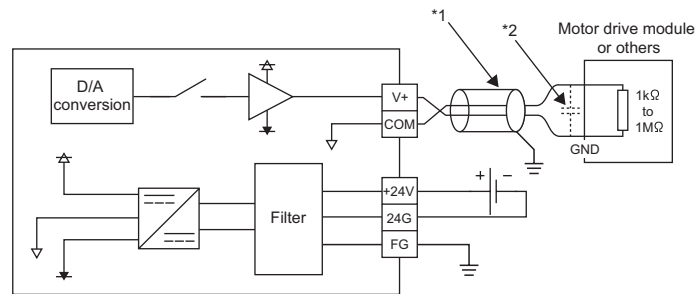

- *1 For the wire, use the shielded twisted pair cable.
- *2 If there is noise or ripples in the external wiring, connect a 0.1 to 0.47 μ F capacitor (25V or higher voltage-resistant product) to the input terminal of the external device.

- For the current output

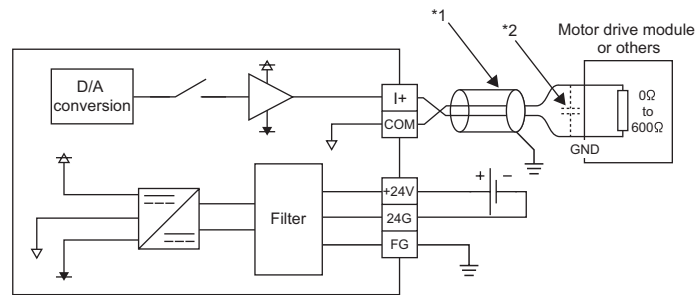

- *1 For the wire, use the shielded twisted pair cable.
- *2 If there is noise or ripples in the external wiring, connect a 0.1 to 0.47 μ F capacitor (25V or higher voltage-resistant product) to the input terminal of the external device.

(e) Wiring method

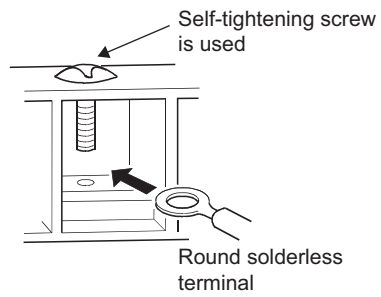

- 1. Loosen the terminal screw. Connect the round solderless terminal as it is.**

Point

- Do not put oil on the terminal and screw. Failure to do so may damage the screw.
 - The number of the applicable solderless terminals must be two or less. When inserting two applicable solderless terminals, insert them back-to-back. Otherwise the screw cannot be tightened and it may damage the screw.
 - Tighten the terminal screw with an applicable screwdriver. Tightening with an inapplicable screwdriver may damage the screw.
-

CHAPTER 7 VARIOUS SETTINGS

This chapter describes the setting procedures of the D/A converter module.

7.1 Parameter Setting

Set the parameter of this module with the network parameter written to the CPU module of the master station. When the setting in GX Works2 and the parameter written to the CPU module do not match, the parameter cannot be written and read. For the setting procedure of the master station, refer to the following.

 User's manual for the master/local module used

Write and read the parameter setting of this module with the CPU module in the STOP status.
(Writing and reading are unavailable in the RUN status.)

Remark

- When points less than the ones of the D/A converter module and extension module are set for the remote I/O signal and remote register, no error occurs. The cyclic transmission is performed for the data of the points set from the start.
- When using the D/A converter module, always enable the block data assurance per station. When it is disabled, correct operation of the D/A converter module cannot be guaranteed.

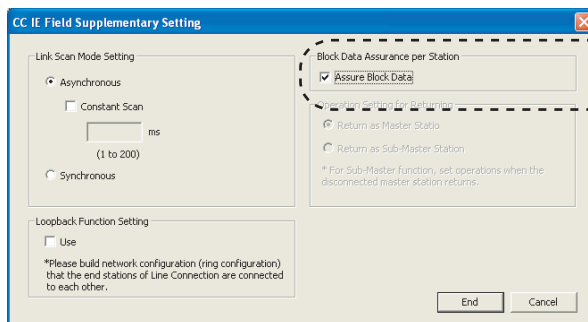

Do not uncheck the box.

For the block data assurance per station, refer to the following.

 User's manual for the master/local module used

- Do not set the parameter using the CCPASET instruction in the master station. Correct operation of the D/A converter module cannot be guaranteed because the module operates with the block data assurance per station disabled when the CCPASET instruction is executed.

1. Display the "CC IE Field Configuration" window.

- When the master/local module is the QJ71GF11-T2

Project window ⇨ [Parameter] ⇨ [Network Parameter] ⇨ [Ethernet/CC IE/MELSECNET] ⇨

 button

- When the master/local module is the LJ71GF11-T2

Project window ⇨ [Parameter] ⇨ [Network Parameter] ⇨ [CC IE Field] ⇨

 button

2. Select the D/A converter module in "List of stations" on the "CC IE Field Configuration" window.

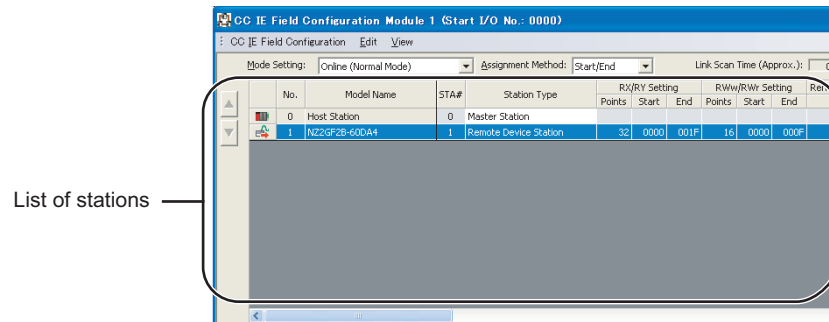

3. Open the "Parameter Processing of Slave Station" window.

 [CC IE Field Configuration] ⇨ [Parameter Processing of Slave Station]

4. Set "Parameter write" for "Method selection".

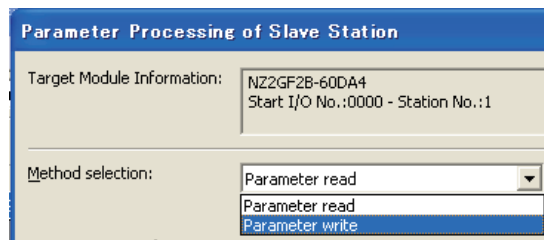

5. Double-click the item to change the setting, and input the setting value.

- Items to input from the pull-down list
Double-click the item to set, to display the pull-down list. Select the item.
- Items to input from the text box
Double-click the item to set, and input the setting value.

Parameter Processing of Slave Station

Target Module Information: N22GF2B-60DA4
Start I/O No.:0000 - Station No.:1

Method selection: Parameter write The parameters are written to the target module.

Parameter Information

Checked parameters are the targets of selected processes.

Select All Cancel All Selections

Name	Initial Value	Read Value	Write Value	Setting Range	Unit	Description
Alert output signal assign...	0xFFFF		0:0024	0:0000 to 0xFF...		Set the signal to be
Error flag assignment	0xFFFF		0:0020	0:0000 to 0xFF...		Set the signal to be
Warning flag assignment	0xFFFF		0:0022	0:0000 to 0xFF...		Set the signal to be
Cyclic data update watch tim...	0			0 to 20	x100ms	Set the cyclic data
Extension I/O setting						
Input response time setting	5: 10ms					Set the input respo
Digital output HOLD/CLEA...	0: CLEAR					Set the output HOL

Basic module parameter

- O/A conversion enable/disab...
- CH1 D/A conversion enabl... 1: Disable
- CH2 D/A conversion enabl... 1: Disable

Display only selectable parameters

Clear All "Write Value"

Process Option

There is no option in the selected process.

-The refreshed device values of remote I/O or remote registers may be overwritten.
-Accesses the PLC CPU by using the current connection destination. Please check if there is any problem with the connection destination.
-Process is executed according to the parameters written in the PLC CPU.
-For information on items not displayed on the screen, please refer to the manual.

Execute

Import... Export... Close

Text box type

Pull-down list type



The box cannot be unchecked.

The list cannot be folded.

Item		Reference
External signal assignment setting	Alert output signal assignment	Page 99, Section 8.11 (3)
	Error flag assignment	
	Warning flag assignment	
Cyclic data update watch time setting		Page 78, Section 8.5
Extension I/O setting	Input response time setting	Page 98, Section 8.11 (1)
	Digital output HOLD/CLEAR setting	
D/A conversion enable/disable setting	CH1 D/A conversion enable/disable setting	Page 74, Section 8.1
	CH2 D/A conversion enable/disable setting	
	CH3 D/A conversion enable/disable setting	
	CH4 D/A conversion enable/disable setting	
Range setting	CH1 Range setting	Page 75, Section 8.3
	CH2 Range setting	
	CH3 Range setting	
	CH4 Range setting	
Analog HOLD/CLEAR setting	CH1 Analog HOLD/CLEAR setting	Page 76, Section 8.4
	CH2 Analog HOLD/CLEAR setting	
	CH3 Analog HOLD/CLEAR setting	
	CH4 Analog HOLD/CLEAR setting	
Alert output function	CH1 Alert output setting	Page 92, Section 8.9
	CH1 Alert output upper limit value	
	CH1 Alert output lower limit value	
	CH2 Alert output setting	
	CH2 Alert output upper limit value	
	CH2 Alert output lower limit value	
	CH3 Alert output setting	
	CH3 Alert output upper limit value	
	CH3 Alert output lower limit value	
	CH4 Alert output setting	
	CH4 Alert output upper limit value	
	CH4 Alert output lower limit value	
Scaling function	CH1 Scaling enable/disable setting	Page 79, Section 8.6
	CH1 Scaling upper limit value	
	CH1 Scaling lower limit value	
	CH2 Scaling enable/disable setting	
	CH2 Scaling upper limit value	
	CH2 Scaling lower limit value	
	CH3 Scaling enable/disable setting	
	CH3 Scaling upper limit value	
	CH3 Scaling lower limit value	
	CH4 Scaling enable/disable setting	
	CH4 Scaling upper limit value	
	CH4 Scaling lower limit value	

6. Click the  button to write the parameter to the D/A converter module.

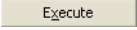
Point

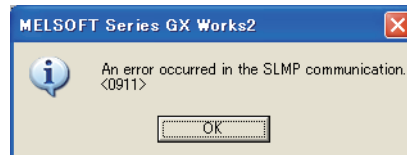

- When using the extension module, also set the parameter of the extension module.
For the parameter of the extension module, refer to the following.
 Manual for the extension module used
- Set all the items for the parameter. If any blank exists, the parameter cannot be written to the D/A converter module.
- To read the parameter from the D/A converter module, set "Parameter read" for "Method selection" and click the  button.
- The parameter is checked when it is written to the D/A converter module. When the following message is displayed during the writing, take corrective action for the error code in < >. ( Page 119, Section 11.2)





7.2 Changing the Parameter

7.2.1 Changing the network configuration

When changing the network configuration diverting the created project, set the parameter in the following procedure.

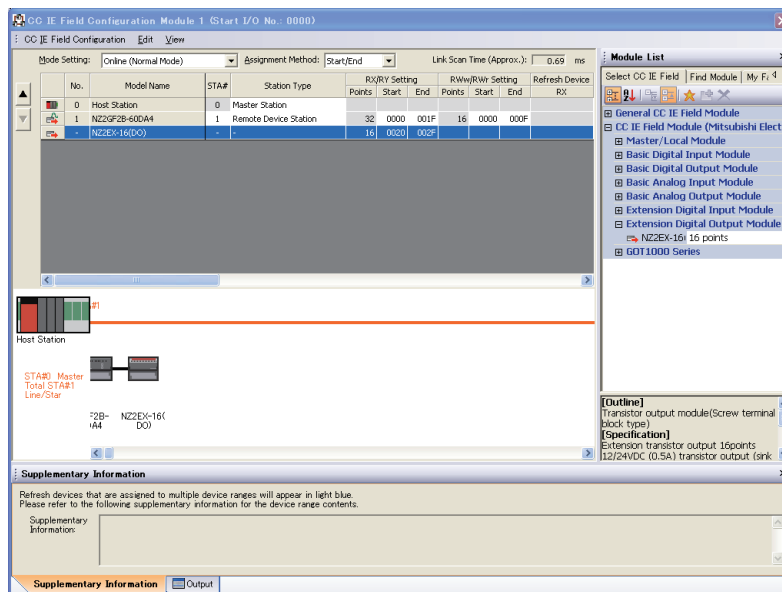
1. Power off the module.
2. Connect the modules again according to the desired network configuration.
3. Power on the module.
4. Display the "CC IE Field Configuration" window.
 - When the master/local module is the QJ71GF11-T2
 - ☞ Project window ⇒ [Parameter] ⇒ [Network Parameter] ⇒ [Ethernet/CC IE/MELSECNET] ⇒  button
 - When the master/local module is the LJ71GF11-T2
 - ☞ Project window ⇒ [Parameter] ⇒ [Network Parameter] ⇒ [CC IE Field] ⇒  button
5. Drag and drop a module to set the slave station. Input a numerical value to set the station number of the station. Change the value as necessary.



6. Close the "CC IE Field Configuration" window.
 - ☞ [CC IE Field Configuration] ⇒ [Close with Reflecting the Setting]
7. Click the  button to display the refresh parameter setting window.

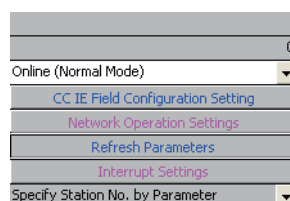

8. Set the refresh parameter. Change the value as necessary.

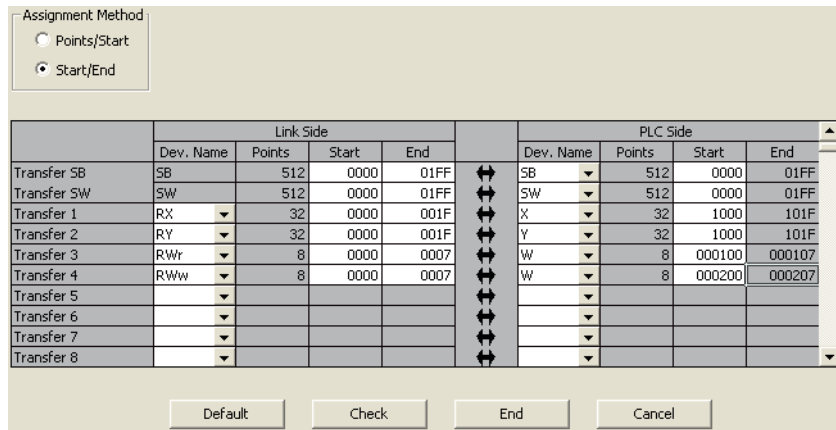

9. Write the set parameter to the CPU module of the master station and reset the CPU module.

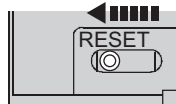

10. Change the status of the CPU module of the master station to RUN.

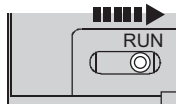

11. The network configuration setting is now completed.

Set the module parameter of the slave station referring to procedure 4 or later in the following section.
 Parameter Setting (☞ Page 63, Section 7.1)

Point!

For the network configuration, match the settings in GX Works2 and the CPU module before setting the module parameter of the slave station. When they are not matched, the module parameter of the slave station cannot be written to the slave station.

7.2.2 Changing the parameter without changing the network configuration

To change only the created module parameter of the slave station without changing the network configuration, set the parameter in the following procedure.

1. Display the "CC IE Field Configuration" window.

- When the master/local module is the QJ71GF11-T2

Project window ⇨ [Parameter] ⇨ [Network Parameter] ⇨
[Ethernet/CC IE/MELSECNET] ⇨  button

- When the master/local module is the LJ71GF11-T2

Project window ⇨ [Parameter] ⇨ [Network Parameter] ⇨ [CC IE Field] ⇨
 button

2. Select the D/A converter module in "List of stations" on the "CC IE Field Configuration" window.

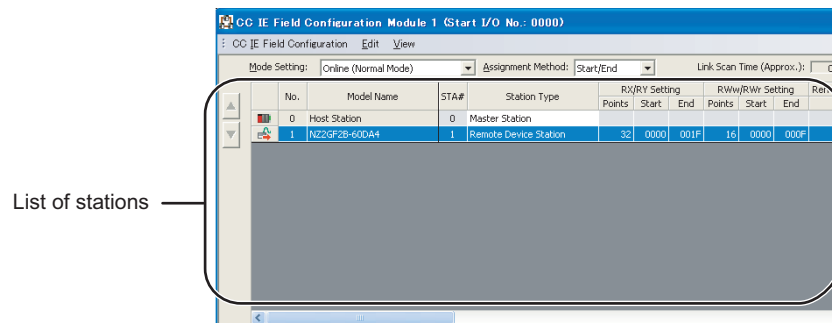

3. Open the "Parameter Processing of Slave Station" window.

 [CC IE Field Configuration] ⇨ [Parameter Processing of Slave Station]

4. Set "Parameter read" for "Method selection".

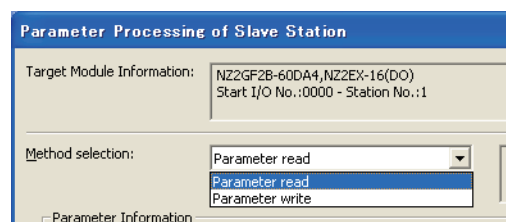

5. Click the button to read the parameter from the D/A converter module.

Name	Initial Value	Read Value	Write Value	Setting Range	Unit	Description
Station parameter						
<input checked="" type="checkbox"/> External signal assignmen...						
Alert output signal assig...	0xFFFF	0xFFFF		0x0000 to 0xFF...		Set the signal to b
Error flag assignment	0xFFFF	0xFFFF		0x0000 to 0xFF...		Set the signal to b
Warning flag assignment	0xFFFF	0xFFFF		0x0000 to 0xFF...		Set the signal to b
<input checked="" type="checkbox"/> Cyclic data update watch ti...	0	0		0 to 20	x100ms	Set the cyclic data
<input checked="" type="checkbox"/> Extension I/O setting						
Input response time setti...	5: 10ms	5: 10ms				Set the input resp
Digital output HOLD/CLE...	0: CLEAR	0: CLEAR				Set the output HOI

6. Set "Parameter write" for "Method selection".

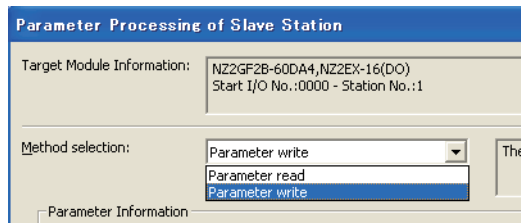

7. Check the read parameter and select the item to be changed from "Write Value". Then set a new value. For the item not to be changed, set the same value as "Read Value" for "Write Value".

Name	Initial Value	Read Value	Write Value	Setting Range	Unit	Description
Station parameter						
<input checked="" type="checkbox"/> External signal assignmen...						
Alert output signal assig...	0xFFFF	0xFFFF	0xFFFF	0x0000 to 0xFF...		Set the signal to b
Error flag assignment	0xFFFF	0xFFFF	0xFFFF	0x0000 to 0xFF...		Set the signal to b
Warning flag assignment	0xFFFF	0xFFFF	0xFFFF	0x0000 to 0xFF...		Set the signal to b
<input checked="" type="checkbox"/> Cyclic data update watch ti...	0	0	0	0 to 20	x100ms	Set the cyclic data
<input checked="" type="checkbox"/> Extension I/O setting						
Input response time setti...	5: 10ms	5: 10ms	5: 10ms			Set the input resp
Digital output HOLD/CLE...	0: CLEAR	0: CLEAR	0: CLEAR			Set the output HOI

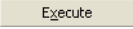
8. Click the  button to write the parameter to the D/A converter module. The parameter change is completed.

7.3 Offset/Gain Setting

When the user range setting is used, configure the offset/gain setting with the following operations.
 When factory default settings are used, the offset/gain setting is not required.

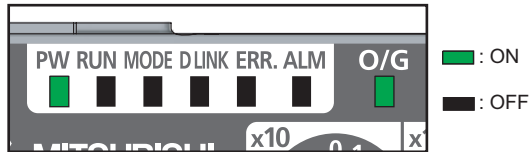
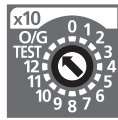

1. Power off the module.
2. Set "O/G" for "x10" of the station number setting switch.
3. Power on the module to check the LED is in the following status.
 RUN LED: OFF
 O/G LED: ON
4. Select the setting target using the SET/SEL button.

▲ Button ▼ Button

[User range setting 1 (-10 to 10V)]

CH1: Offset	V	I	ch1	2	3	4	OFFSET	GAIN
CH1: Gain	V	I	ch1	2	3	4	OFFSET	GAIN
CH2: Offset	V	I	ch1	2	3	4	OFFSET	GAIN
CH2: Gain	V	I	ch1	2	3	4	OFFSET	GAIN
CH3: Offset	V	I	ch1	2	3	4	OFFSET	GAIN
CH3: Gain	V	I	ch1	2	3	4	OFFSET	GAIN
CH4: Offset	V	I	ch1	2	3	4	OFFSET	GAIN
CH4: Gain	V	I	ch1	2	3	4	OFFSET	GAIN

[User range setting 2 (0 to 20mA)]

CH1: Offset	V	I	ch1	2	3	4	OFFSET	GAIN
CH1: Gain	V	I	ch1	2	3	4	OFFSET	GAIN
CH2: Offset	V	I	ch1	2	3	4	OFFSET	GAIN
CH2: Gain	V	I	ch1	2	3	4	OFFSET	GAIN
CH3: Offset	V	I	ch1	2	3	4	OFFSET	GAIN
CH3: Gain	V	I	ch1	2	3	4	OFFSET	GAIN
CH4: Offset	V	I	ch1	2	3	4	OFFSET	GAIN
CH4: Gain	V	I	ch1	2	3	4	OFFSET	GAIN

5. For the selected channel, adjust the analog output value by using the "+" and "-" switches.
 Pressing the "+" switch increases the analog output value. Pressing the "-" switch decreases the analog output value.
6. Keep pressing the ▲ button until the RUN LED turns on.
 After the RUN LED turns on, release the ▲ button. While the RUN LED is on, the offset value or gain value is being written to the nonvolatile memory. After the writing, the RUN LED turns off. After checking that the RUN LED turns off, go to the next step.
7. When setting another channel, go back to step 4.
8. After setting all the channels, power off the module.

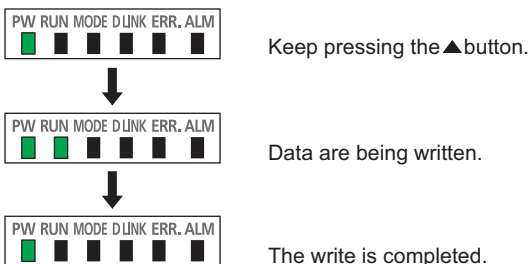

Point 

- Configure the offset/gain setting in accordance with the actual use situation.
Connection to the CC-Link IE Field Network is not required.
- Configure the offset/gain setting in the range satisfying the following condition. When the setting value out of the range is configured, the maximum resolution and accuracy of the module may not fall within the range shown in the following performance specifications.
 - I/O Conversion Characteristic of D/A Conversion ( Page 152, Appendix 4)
- Because the offset value and gain value are written to the nonvolatile memory in the D/A converter module, the set values can be used even after the module is powered on and off.
- Configure the offset/gain setting in the condition of "Offset value < Gain value".
The offset and gain values are checked in the D/A converter module when Initial data setting request flag (RY9) is turned on and off with the user range setting 1 or user range setting 2 set to Range setting (address: 0103_H). If a wrong condition (offset value \geq gain value) is set, an error occurs. The error code (040□_H) is stored in Latest error code (RWr0) when they are checked, Error flag (RXA) is turned on, and the ERR. LED turns on.

CHAPTER 8 FUNCTION

This chapter describes the details of the functions available in the D/A converter module, and the setting procedures for those functions.

For details on remote I/O signals, remote registers, and remote buffer memory, refer to the following.

- Details of Remote I/O Signals (☞ Page 131, Appendix 1)
- Details of Remote Register Areas (☞ Page 136, Appendix 2)
- Details of Remote Buffer Memory Areas (☞ Page 140, Appendix 3)

8.1 D/A Conversion Enable/Disable Function

Sets whether to enable or disable D/A conversion for each channel.

Disabling the D/A conversion for unused channels reduces the conversion cycles.

(1) Setting procedure

1. Set "Parameter write" for "Method selection".

☞ "CC IE Field Configuration" window ⇨ Select a D/A converter module in "List of stations" ⇨ [CC IE Field Configuration] ⇨ [Parameter Processing of Slave Station]

2. Set "CH□ D/A conversion enable/disable setting" to "0: Enable".

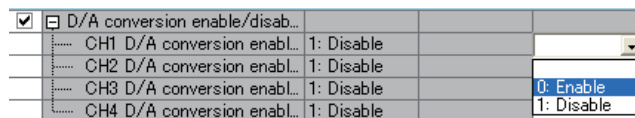

8.2 D/A Output Enable/Disable Function

Whether to output the D/A conversion value or the offset value can be set for each channel.

The conversion speed is constant, regardless of the output enable/disable status.

(1) Setting procedure

Use CH□ Output enable/disable flag (RY10 to RY13) for the setting.

CH□ Output enable/disable flag (RY10 to RY13)	Analog output
Output enable (ON)	The D/A conversion value is output.
Output disable (OFF)	The offset value is output.

8.3 Range Switching Function

The output range can be selected for each channel from the following ranges:

- Factory default range (4 to 20mA, 0 to 20mA, 1 to 5V, 0 to 5V, -10 to 10V)
- User range (user range setting 1, user range setting 2)

(1) Setting procedure

1. Set "Parameter write" for "Method selection".

 "CC IE Field Configuration" window ⇨ Select a D/A converter module in "List of stations" ⇨ [CC IE Field Configuration] ⇨ [Parameter Processing of Slave Station]

2. Set "CH□ D/A conversion enable/disable setting" to "0: Enable".

<input checked="" type="checkbox"/>	D/A conversion enable/disable...			
	CH1 D/A conversion enabl...	1: Disable		
	CH2 D/A conversion enabl...	1: Disable		
	CH3 D/A conversion enabl...	1: Disable	0: Enable	
	CH4 D/A conversion enabl...	1: Disable	1: Disable	

3. Set "CH□ Range setting".

<input checked="" type="checkbox"/>	Range setting			
	CH1 Range setting	0: 4 to 20mA		
	CH2 Range setting	0: 4 to 20mA		
	CH3 Range setting	0: 4 to 20mA	0: 4 to 20mA	
	CH4 Range setting	0: 4 to 20mA	1: 0 to 20mA	
<input checked="" type="checkbox"/>	Analog HOLD/CLEAR setting			
	CH1 Analog output HOLD/...	0: CLEAR	2: 1 to 5V	
	CH2 Analog output HOLD/...	0: CLEAR	3: 0 to 5V	
	CH3 Analog output HOLD/...	0: CLEAR	4: -10 to 10V	
			5: User range setting1(-10 to 10V)	
			6: User range setting2(0 to 20mA)	

Point

When switching the output range, set Disable (OFF) to CH□ Output enable/disable flag (RY10 to RY13) before setting a value (within the range an external device allows) for CH□ Digital value (RWw2 to RWw5).
For example, when the output range is from 0 to 5V and 12000 is set for CH□ Digital value (RWw2 to RWw5), 5V is output. In this case, if the output range is changed to -10 to 10V, 7.5V is output because 12000 remains set for CH□ Digital value (RWw2 to RWw5).

8.4 Analog Output HOLD/CLEAR Function

Whether to hold or clear the output analog value can be set, according to the CPU module operating status (RUN, STOP, or stop error).

(1) Combination of analog output status

The following table shows how the analog output status changes, depending on the combination of settings for D/A conversion enable/disable setting (address: 0102_H) and CH□ Output enable/disable flag (RY10 to RY13).

Execution status	D/A conversion enable/disable setting (address: 0102 _H)	Enable		Disable
	CH□ Output enable/disable flag (RY10 to RY13)	Enable		Disable
	Analog output HOLD/CLEAR setting (address: 0104 _H)	HOLD	CLEAR	HOLD or CLEAR
Analog output status of when the CPU module is in the RUN status		The analog value D/A-converted from the digital value is output.		Offset value
Analog output status of when the CPU module is in the STOP status		Hold	Offset value	Offset value
Analog output status of when the CPU module is in stop error		Hold	Offset value	Offset value
Analog output status of when the D LINK LED is off*2		Hold	Offset value	Offset value
Analog output status of when the D/A module receives the instruction of the data link stop from the master station		Hold	Offset value	Offset value
Analog output status of when the D/A module is set reserved from the master station		Hold	Offset value	Offset value
Analog output status of when the out-of-range digital value error occurs		The upper limit value or lower limit value of analog value is output.		Offset value
Analog output status of when the out-of-range setting error occurs		0V/0mA	0V/0mA	0V/0mA
Analog output status of when a hardware failure*1 occurs		0V/0mA	0V/0mA	0V/0mA

*1 This is when the program operation is not completed within the estimated time in the CPU module due to a hardware failure in the D/A converter module. In this case, Remote READY (RXB) and the RUN LED of the D/A converter module turn off.

*2 The analog output HOLD/CLEAR function may be executed even when the D LINK LED is on if the cyclic data update watch time is set. For details, refer to the following.

Cyclic Data Update Watch Function (📄 Page 78, Section 8.5)

(2) Setting procedure

1. Set "Parameter write" for "Method selection".

 "CC IE Field Configuration" window ⇨ Select a D/A converter module in "List of stations" ⇨
[CC IE Field Configuration] ⇨ [Parameter Processing of Slave Station]

2. Set "CH□ D/A conversion enable/disable setting" to "0: Enable".

<input checked="" type="checkbox"/>	<input type="checkbox"/> D/A conversion enable/disable...			
	CH1 D/A conversion enabl...	1: Disable		
	CH2 D/A conversion enabl...	1: Disable		
	CH3 D/A conversion enabl...	1: Disable		0: Enable
	CH4 D/A conversion enabl...	1: Disable		1: Disable

3. Set "CH□ Analog output HOLD/CLEAR setting".

<input checked="" type="checkbox"/>	<input type="checkbox"/> Analog HOLD/CLEAR setting			
	CH1 Analog output HOLD/...	0: CLEAR		
	CH2 Analog output HOLD/...	0: CLEAR		
	CH3 Analog output HOLD/...	0: CLEAR		0: CLEAR
	CH4 Analog output HOLD/...	0: CLEAR		1: HOLD

8.5 Cyclic Data Update Watch Function

The update intervals of cyclic data are monitored. The last output value is held or cleared when the cyclic transmission stop status continues longer than the set monitoring time.

The cyclic transmission stop status is the status that the D LINK LED is flashing (Data link in operation (cyclic transmission stopped)) or off (Data link not performed (disconnected)).

Set whether to hold or clear the output value using the digital output HOLD/CLEAR setting function and the analog output HOLD/CLEAR setting function.

For the digital output HOLD/CLEAR setting function, refer to the following.

- Digital output HOLD/CLEAR setting function (☞ Page 98, Section 8.11)

For the analog output HOLD/CLEAR setting function, refer to the following.

- Analog output HOLD/CLEAR setting function (☞ Page 76, Section 8.4)

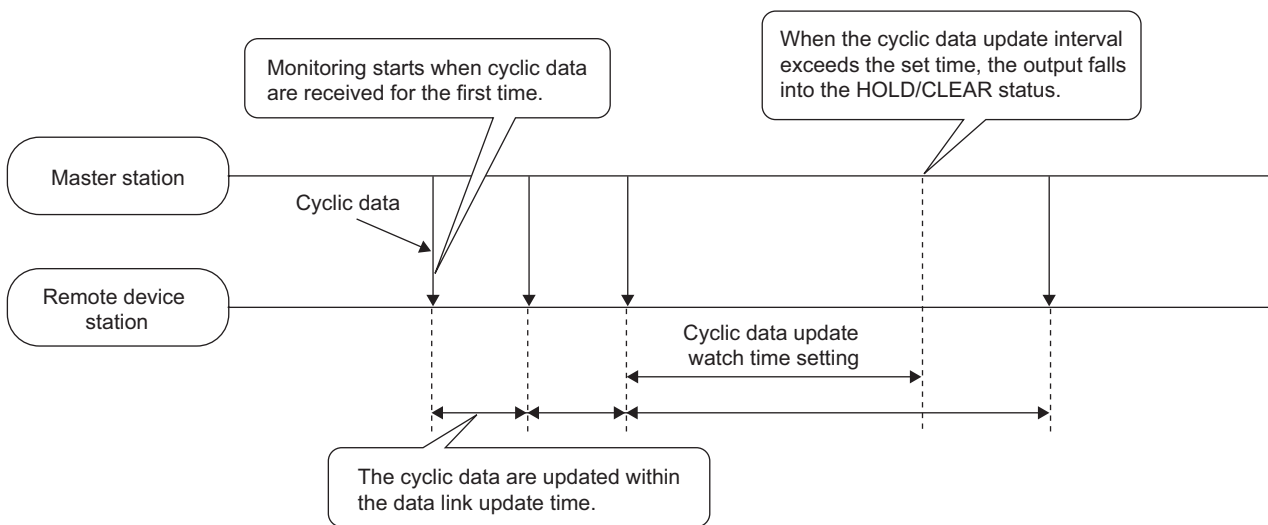

(1) Setting procedure

1. Set "Parameter write" for "Method selection".

☞ "CC IE Field Configuration" window ⇨ Select a D/A converter module in "List of stations" ⇨ [CC IE Field Configuration] ⇨ [Parameter Processing of Slave Station]

2. Set "CH□ D/A conversion enable/disable setting" to "0: Enable".

<input checked="" type="checkbox"/>	D/A conversion enable/disable...			
	CH1 D/A conversion enabl...	1: Disable		
	CH2 D/A conversion enabl...	1: Disable		
	CH3 D/A conversion enabl...	1: Disable	0: Enable	
	CH4 D/A conversion enabl...	1: Disable	1: Disable	

3. Set the monitoring time in "Cyclic data update watch time setting".

<input checked="" type="checkbox"/>	Cyclic data update watch tim...	0		1
-------------------------------------	---------------------------------	---	--	---

Item	Setting range
Cyclic data update watch time setting	<ul style="list-style-type: none"> • 0 (Not monitor) • 1 to 20 (0.1 to 2 seconds in units of 100ms)



Set the greater value for the cyclic data update watch time setting than that of the link scan time.

8.6 Scaling Function

The D/A converter module scale-converts the digital value to the set range of the scaling upper limit value and scaling lower limit value. The programming for scale conversion can be reduced.

(1) Concept of scaling setting

The setting for scaling lower and upper limit values differs depending on whether the factory default setting or the user range setting is used for the analog output range.

(a) When the factory default setting is used for the analog output range

- Set a value corresponding to the upper limit value of the analog output value in the range setting for the scaling upper limit value.
- Set a value corresponding to the lower limit value of the analog output value in the range setting for the scaling lower limit value.

(b) When the user range setting is used for the analog output range

- Set a value corresponding to the gain value for the scaling upper limit value.
- Set a value corresponding to the offset value for the scaling lower limit value.

(2) Calculation of the scaling value

Scale conversion is performed on the digital values using the following formula:

(Values after the decimal point are rounded down during scale conversion.)

- When the output range is 4 to 20mA, 0 to 20mA, 1 to 5V, or 0 to 5V, user range setting 1, or user range setting 2

$$\text{Digital value used for D/A conversion} = \frac{12000}{SH - SL} \times (DX - SL)$$

- When the output range is -10 to 10V

$$\text{Digital value used for D/A conversion} = \frac{32000}{SH - SL} \times (DX - SL) - 16000$$

Item	Description
Dx	Digital value
SH	Scaling upper limit value
SL	Scaling lower limit value

(3) Setting procedure

1. Set "Parameter write" for "Method selection".

 "CC IE Field Configuration" window ⇨ Select a D/A converter module in "List of stations" ⇨ [CC IE Field Configuration] ⇨ [Parameter Processing of Slave Station]

2. Set "CH□ D/A conversion enable/disable setting" to "0: Enable".

<input checked="" type="checkbox"/>	<input type="checkbox"/> D/A conversion enable/disable...			
 CH1 D/A conversion enabl...	1: Disable		
 CH2 D/A conversion enabl...	1: Disable		
 CH3 D/A conversion enabl...	1: Disable	0: Enable	
 CH4 D/A conversion enabl...	1: Disable	1: Disable	

3. Set "CH□ Scaling enable/disable setting" to "0: Enable".

<input checked="" type="checkbox"/>	<input type="checkbox"/> Scaling function			
 CH1 Scaling enable/disable...	1: Disable		
 CH1 Scaling upper limit va...	0		
 CH1 Scaling lower limit va...	0	0: Enable	
 CH2 Scaling enable/disable...	1: Disable	1: Disable	

4. Set values for "CH□ Scaling lower limit value" and "CH□ Scaling upper limit value".

<input checked="" type="checkbox"/>	<input type="checkbox"/> Scaling function			
 CH1 Scaling enable/disable...	1: Disable	0: Enable	
 CH1 Scaling upper limit va...	0	10000	
 CH1 Scaling lower limit va...	0	4000	

Item	Setting range
CH□ Scaling upper limit value	-32000 to 32000
CH□ Scaling lower limit value	

Point 

- Even if the scaling upper limit value and the scaling lower limit value are set so that the change is larger than the maximum resolution described in the performance specifications, the resolution will not increase.
- Scaling settings must meet the following condition:
Scaling upper limit value > Scaling lower limit value

(4) Example of scaling setting

Ex. 1: When values are set for a channel with output range of 0 to 5V as follows:

- "CH□ Scaling enable/disable setting": "0: Enable"
- "CH□ Scaling upper limit value": 10000
- "CH□ Scaling lower limit value": 2000

<input checked="" type="checkbox"/>	Scaling function		
	CH1 Scaling enable/disable...	1: Disable	0: Enable
	CH1 Scaling upper limit va...	0	10000
	CH1 Scaling lower limit val...	0	2000

The digital values and scale-converted digital values are as follows:

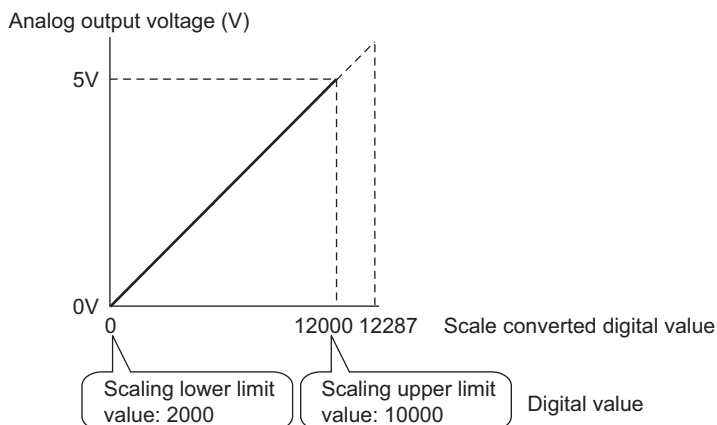

Digital value	Digital value after scale conversion	Analog output voltage (V)
2000	0	0
3600	2400	1
5200	4800	2
6800	7200	3
8400	9600	4
10000	12000	5

Ex. 2: When values are set for a channel with output range of -10 to 10V as follows:

- "CH□ Scaling enable/disable setting": "0: Enable"
- "CH□ Scaling upper limit value": 12000
- "CH□ Scaling lower limit value": 4000

<input checked="" type="checkbox"/>	Scaling function		
<input type="checkbox"/>	CH1 Scaling enable/disable...	1: Disable	0: Enable
<input type="checkbox"/>	CH1 Scaling upper limit va...	0	12000
<input type="checkbox"/>	CH1 Scaling lower limit va...	0	2000

The digital values and scale-converted digital values are as follows:

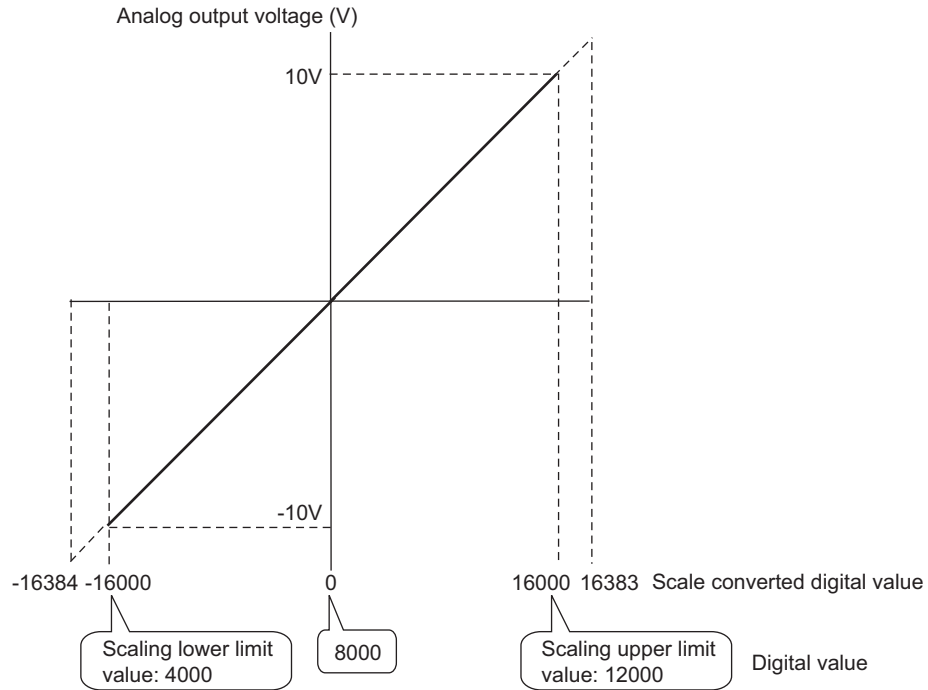

Digital value	Digital value after scale conversion	Analog output voltage (V)
4000	-16000	-10
6000	-8000	-5
8000	0	0
10000	8000	5
12000	16000	10

Ex. 3: When values are set for a channel with the user range 1 of 2 to 10V as follows:

- "CH□ Scaling enable/disable setting": "0: Enable"
- "CH□ Scaling upper limit value": 8000
- "CH□ Scaling lower limit value": 2000

<input checked="" type="checkbox"/>	Scaling function		
<input type="checkbox"/>	CH1 Scaling enable/disable	1: Disable	0: Enable
<input type="checkbox"/>	CH1 Scaling upper limit value	0	8000
<input type="checkbox"/>	CH1 Scaling lower limit value	0	2000

The digital values and scale-converted digital values are as follows:

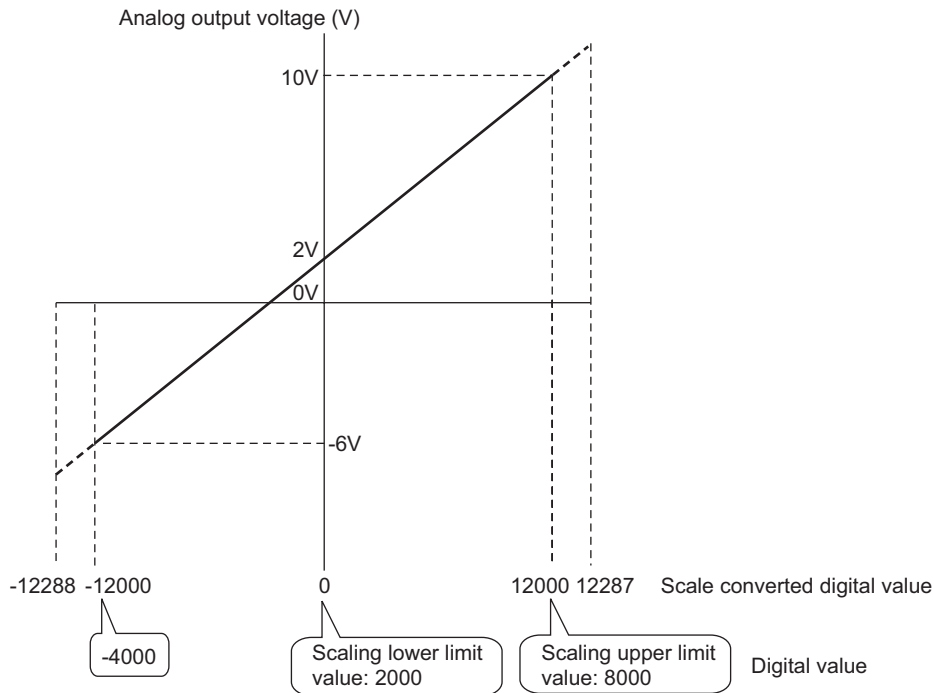

Digital value	Digital value after scale conversion	Analog output voltage (V)
-4000	-12000	-6
-1000	-6000	-2
2000	0	2
5000	6000	6
8000	12000	10

- When using the scaling function, the digital value before scaling can be set to a value out of the range of the scaling upper and lower limit values (dotted line area in the I/O characteristics). However, use the scaling function within the range of the analog output practical range (solid line area in the I/O characteristics). If the value is out of the analog output practical range, the maximum resolution and accuracy may not fall within the range of performance specifications.
- The default digital value "0" may not be appropriate depending on the scaling function setting. Especially in the examples 1, 2, and 3, the out-of-range digital value error (error code: 060□) occurs if CH□ Output enable/disable flag (RY10 to RY13) is turned on with the digital value being "0". The following shows the error codes that occur.

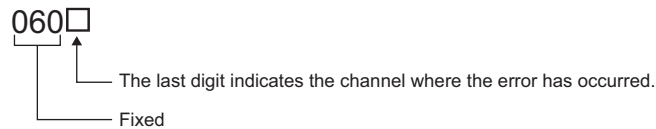

Therefore, set an appropriate digital value within the scaling range before turning on CH□ Output enable/disable flag (RY10 to RY13).

- When using the user range, note that the scaling lower limit value is equal to the offset value.
-

8.7 Shift Function

Using this function, the D/A converter module outputs the converted digital value with the shifting set value added, in analog.

When the shifting set value is changed, it is reflected to the analog output value in real time. Therefore, fine adjustment can be easily performed when the system starts.

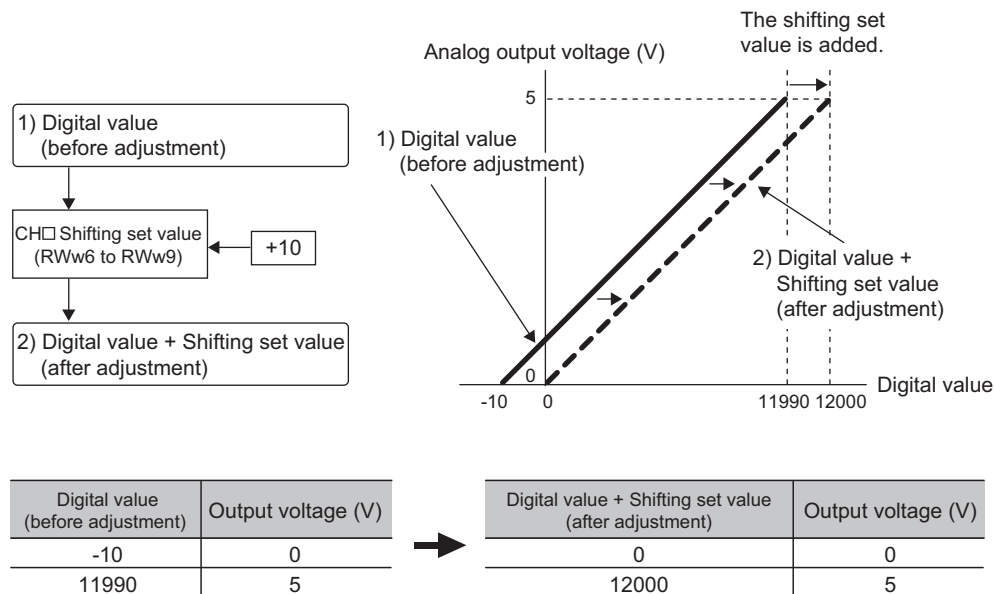

(1) Operation of the shift function

The shifting set value is added to a digital value, and the added digital value is output in analog.

When the scaling function is used, the scale conversion is executed after the addition by the shift function.

The default value of the shifting set value is "0". If some value is set to the shifting set value, the shifting set value is added regardless of the status change (OFF → ON → OFF) of Initial data setting request flag (RY9).

(2) Setting procedure

1. Set "Parameter write" for "Method selection".

☞ "CC IE Field Configuration" window ⇨ Select a D/A converter module in "List of stations" ⇨
[CC IE Field Configuration] ⇨ [Parameter Processing of Slave Station]

2. Set "CH□ D/A conversion enable/disable setting" to "0: Enable".

<input checked="" type="checkbox"/>	D/A conversion enable/disable...			
	CH1 D/A conversion enabl...	1: Disable		
	CH2 D/A conversion enabl...	1: Disable		
	CH3 D/A conversion enabl...	1: Disable		0: Enable
	CH4 D/A conversion enabl...	1: Disable		1: Disable

3. Set a value for CH□ Shifting set value (RWw6 to RWw9).

The default value of the shifting set value is "0".

Item	Setting range
CH□ Shifting set value (RWw6 to RWw9)	-32768 to 32767

Point

If the digital value exceeds the range of -32768 to 32767 as a result of shift addition, the digital operation value is fixed to the lower limit value (-32768) or the upper limit value (32767).

(3) Setting example

Ex. When the following settings are used for a channel with output range of -10 to 10V:

- CH□ Shifting set value (RWw6 to RWw9): 250

The digital value is as follows:

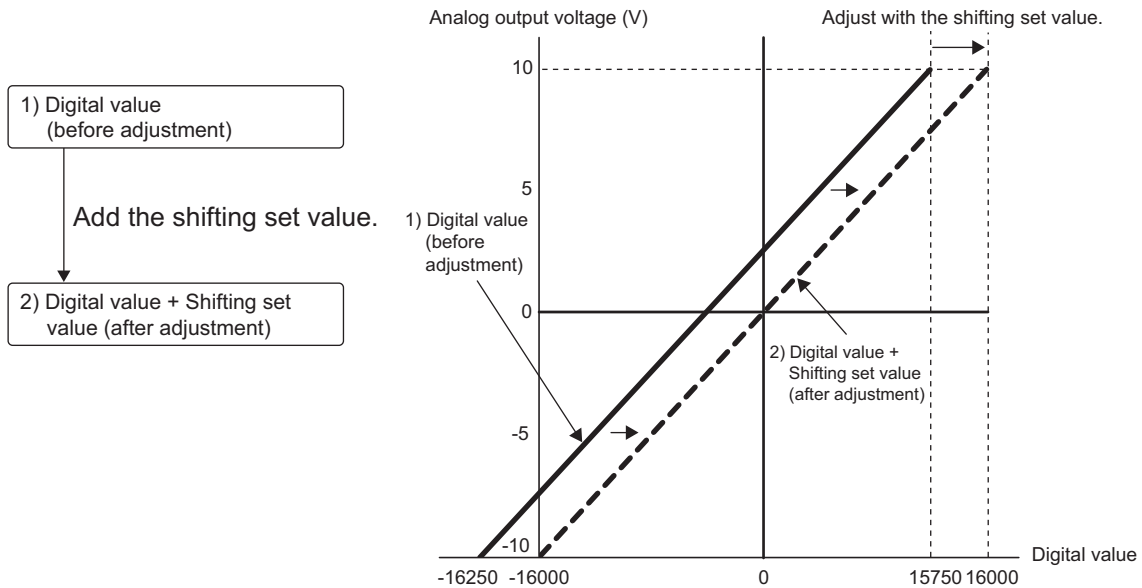

Analog output voltage (V)	Digital value (before adjustment)	Digital value + Shifting set value (after adjustment)
-10	-16250	-16000
-5	-8250	-8000
0	-250	0
5	7750	8000
10	15750	16000

(4) Setting example of when both the scaling function and shift function are used

Ex. When the following settings are used for a channel with output range of 0 to 5V:

- "CH□ Scaling enable/disable setting": "0: Enable"
- "CH□ Scaling upper limit value": 9000
- "CH□ Scaling lower limit value": 3000
- CH□ Shifting set value (RWw6 to RWw9): -25

The digital value is as follows:

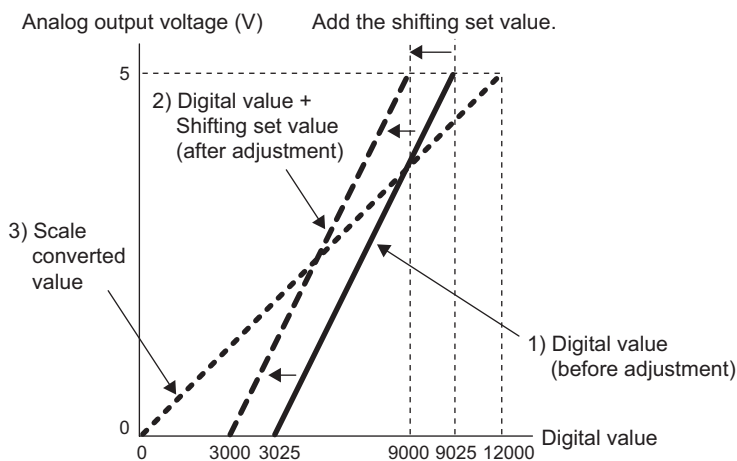
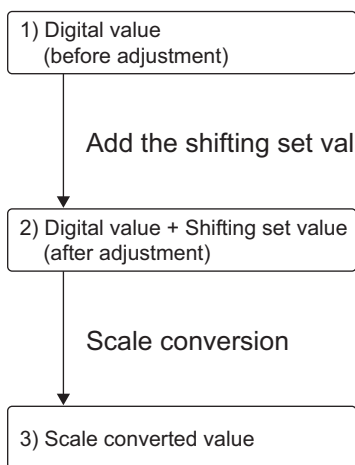

Analog output voltage (V)	Digital value	Digital value + Shifting set value	Value after scaling
0	3025	3000	0
1	4225	4200	2400
2	5425	5400	4800
3	6625	6600	7200
4	7825	7800	9600
5	9025	9000	12000

1. Set "Parameter write" for "Method selection".

 "CC IE Field Configuration" window ⇨ Select a D/A converter module in "List of stations" ⇨ [CC IE Field Configuration] ⇨ [Parameter Processing of Slave Station]

2. Set "CH□ D/A conversion enable/disable setting" to "0: Enable".

<input checked="" type="checkbox"/>	<input type="checkbox"/> D/A conversion enable/disable...			
 CH1 D/A conversion enabl...	1: Disable		
 CH2 D/A conversion enabl...	1: Disable		
 CH3 D/A conversion enabl...	1: Disable		0: Enable
 CH4 D/A conversion enabl...	1: Disable		1: Disable

3. Set "CH□ Scaling enable/disable setting" to "0: Enable".

<input checked="" type="checkbox"/>	<input type="checkbox"/> Scaling function			
 CH1 Scaling enable/disable...	1: Disable		0: Enable
 CH1 Scaling upper limit va...	0		
 CH1 Scaling lower limit va...	0		0: Enable
 CH2 Scaling enable/disable...	1: Disable		1: Disable

4. Set values for "CH□ Scaling lower limit value" and "CH□ Scaling upper limit value".

<input checked="" type="checkbox"/>	<input type="checkbox"/> Scaling function			
 CH1 Scaling enable/disable...	1: Disable		0: Enable
 CH1 Scaling upper limit va...	0		9000
 CH1 Scaling lower limit va...	0		3000

5. Set "-25" for "CH□ Shifting set value (RWw6 to RWw9)".

8.8 Digital Value Range Check Function

An error is output when the digital value is out of the digital input range for the output range.

(1) Notification of a check code

When the digital value is greater than the upper limit of the setting range or smaller than the lower limit of the setting range, it is notified with the following operation.

- The check code is stored in CH□ Set value check code (RWr2 to RWr5).

For details on check codes, refer to the following.

 Page 136, Appendix 2 (3)

- Out-of-range digital value (060□) is stored in Latest warning code (RWr1).
- Warning flag (RX7) turns ON.
- The ALM LED flashes.

For the setting range for the digital value, refer to the following.

Output range setting	When the scaling function is disabled		When the scaling function is enabled*1
	Setting range (Actual range)	Digital value when a value out of the setting range is written	Setting range
4 to 20mA	-288 to 12287 (Actual range: 0 to 12000)	12288 or more: 12287 -289 or less: -288	-32768 to 32767 (Maximum actual range: -32000 to 32000)
0 to 20mA			
1 to 5V			
0 to 5V			
-10 to 10V	-16384 to 16383 (Actual range: -16000 to 16000)	16384 or more: 16383 -16385 or less: -16384	
User range setting 1 (-10 to 10V)	-12288 to 12287 (Actual range: -12000 to 12000)	12288 or more: 12287 -12289 or less: -12288	
User range setting 2 (0 to 20mA)	-288 to 12287 (Actual range: 0 to 12000)	12288 or more: 12287 -289 or less: -288	

*1 The setting range and the actual range of when the scaling function is enabled depend on the settings in the scaling upper limit value and the scaling lower limit value.

(2) Operation of when an error is notified with a check code

When the digital value is greater than the upper limit of the setting range or smaller than the lower limit of the setting range, analog output is as follows:

- When the digital value is greater than the upper limit of the setting range, the analog value is output with the upper limit of the setting range.
- When the digital value is smaller than the lower limit of the setting range, the analog value is output with the lower limit of the setting range.

The analog output value returns to the normal value when the digital value falls within the setting range. However, the indicated notification remains as follows:

- Once a check code is stored, it is not reset automatically.
- Warning flag (RX7) remains ON.
- The ALM LED remains flashing.

(3) Resetting a check code

The check codes can be reset by either of the following two methods.

- Write a digital value within the setting range, and turn on and off Error clear request flag (RYA).
- Turn on and off Initial data setting request flag (RY9).

(4) When the scaling function is set enabled

When Scaling enable/disable setting (address: 010E_H) is set to Enable (0), the scale-converted digital value is the target for the check code.

Point

When the scale-converted digital value is out of the setting range, a slight inaccuracy may be contained in the target digital value for the check code when the check code is stored due to an operational error in the scale conversion.

(5) When the shift function is set enabled

When a value is set for CH□ Shifting set value (RWw6 to RWw9), the value with the shifting set value added is the target for the check code.

(6) Operation example of the check code detection

Ex. When values are set for a channel with output range of -10 to 10V as follows:

- "CH□ Scaling enable/disable setting": "0: Enable"
- "CH□ Scaling upper limit value": 24000
- "CH□ Scaling lower limit value": -24000
- "CH□ Shifting set value (RWw6 to RWw9)": -200

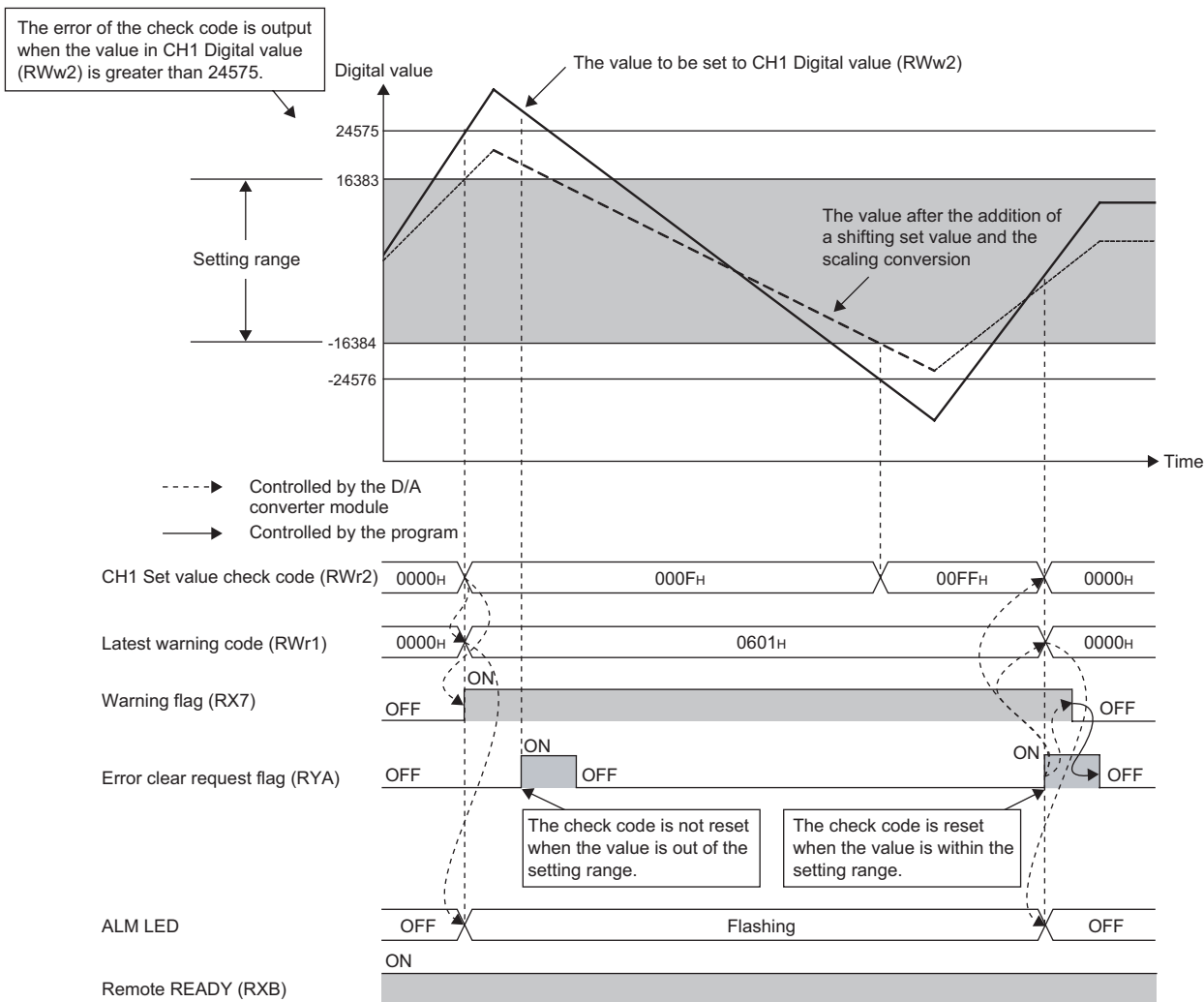

8.9 Alert Output Function

This function outputs alert when a digital value is in the range set in advance.

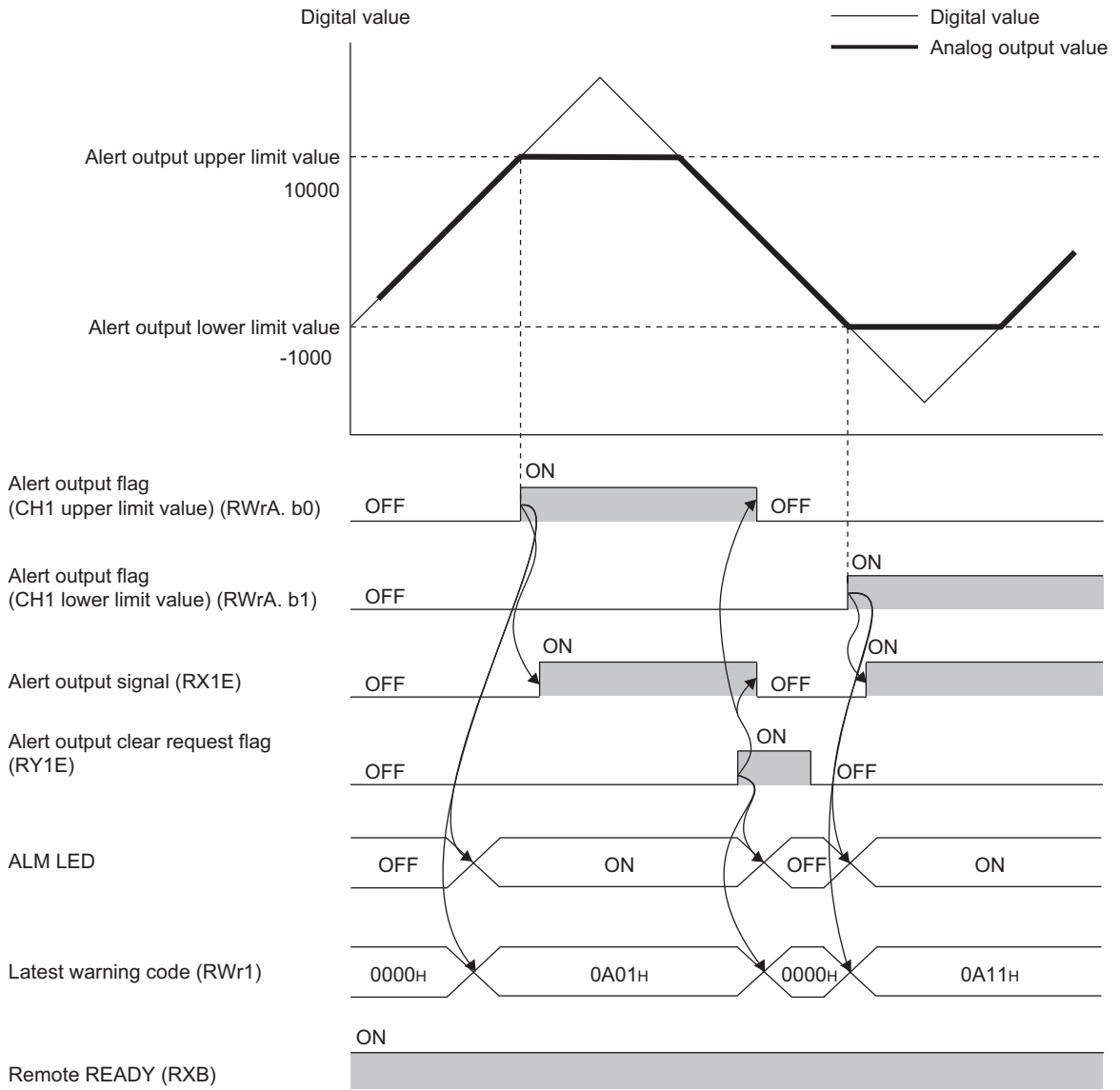

(1) Alert output notification

When the digital value is greater than the alert output upper limit value, or smaller than the alert output lower limit value, alert notifications are made by Alert output flag (RWrA), Alert output signal (RX1E) and the ALM LED turning ON.

- Alert output flag (RWrA): The bit corresponding to the alert is on. (Page 137, Appendix 2 (4))
- Alert output signal (RX1E): ON
- ALM LED: ON

In addition, alarm code 0A△□ gets stored in Latest warning code (RWr1).

The alarm code that is stored is shown below:

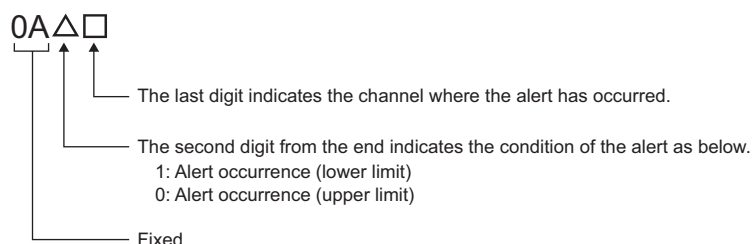

(2) Operation of the alert output function

When the digital value exceeds the alert output upper limit value or is below the alert output lower limit value, an alert is output and the analog output value becomes any of the following:

- When the digital value exceeds the alert output upper limit value: An analog value converted from the digital value of the alert output upper limit value is output.
- When the digital value is below the alert output lower limit value: An analog value converted from the digital value of the alert output lower limit value is output.

After an alert occurs, the analog output value returns to the normal value by changing the digital value to a value within the setting range. However, Alert output flag (RWrA) and Alert output signal (RX1E) are not cleared. (The ALM LED remains ON.)

(3) Clearing the alert output

The alert output can be cleared by either of the following two methods.

- Turning on and off Alert output clear request flag (RY1E)
- Turning on and off Initial data setting request flag (RY9)

When the alert output is cleared, the D/A converter module results in the following state:

- Alert output flag (RWrA) is cleared.
- Alert output signal (RX1E) turns off.
- The ALM LED turns off.
- The alarm code 0A△□, which is stored in Latest warning code (RWr1), is cleared.

(4) When the scaling function is set enabled

When Scaling enable/disable setting (address: 010E_H) is set to Enable (0), the scale-converted digital value is the target for the alert.

When setting CH1 Alert output upper limit value (address: 0106_H) to CH4 Alert output lower limit value (address: 010D_H), set values considering the scaling range.

(5) When the shift function is set enabled

When a value is set to CH□ Shifting set value (RWw6 to RWw9), the value with the shifting set value added is the target for the alert.

(6) Setting procedure

1. Set "Parameter write" for "Method selection".

 "CC IE Field Configuration" window ⇨ Select a D/A converter module in "List of stations" ⇨ [CC IE Field Configuration] ⇨ [Parameter Processing of Slave Station]

2. Set "CH□ D/A conversion enable/disable setting" to "0: Enable".

<input checked="" type="checkbox"/>	D/A conversion enable/disab...			
 CH1 D/A conversion enabl...	1: Disable		
 CH2 D/A conversion enabl...	1: Disable		
 CH3 D/A conversion enabl...	1: Disable		0: Enable
 CH4 D/A conversion enabl...	1: Disable		1: Disable

3. Set "CH□ Alert output setting" to "0: Enable".

<input checked="" type="checkbox"/>	Alert output function			
 CH1 Alert output setting	1: Disable		
 CH1 Alert output upper lim...	0		
 CH1 Alert output lower lim...	0		0: Enable
 CH2 Alert output setting	1: Disable		1: Disable

4. Set values for "CH□ Alert output upper limit value" and "CH□ Alert output lower limit value".

<input checked="" type="checkbox"/>	Alert output function			
 CH1 Alert output setting	1: Disable		0: Enable
 CH1 Alert output upper lim...	0		16000
 CH1 Alert output lower lim...	0		4000

Item	Setting range
CH□ Alert output upper limit value	-32768 to 32767
CH□ Alert output lower limit value	

8.10 Error Notification Function

When an error, warning, or alarm occurs, the D/A converter module notifies the master station of it using remote input signals and remote registers.

Remark

The notification of the error, warning, or alarm can be checked on the LED on the front of the module. For details, refer to the following.

- PART NAMES (Page 19, CHAPTER 2)

(1) Notification of an error

The D/A converter module notifies the master station of an error in the following method.

Item	Description	Reference
Error flag (RXA)	Turns on when a moderate error or major error occurs.	Page 133, Appendix 1.1 (3)
Latest error code (RWr0)	An error code is stored when a moderate error or major error occurs.	Page 136, Appendix 2 (1)

(a) Method for clearing an error

The method for clearing an error depends on the error type.

Error type	Clearing an error
Major error	The error cannot be cleared.
Moderate error	Turn on Error clear request flag (RYA) or Initial data setting request flag (RY9) after removing the error cause.

(2) Notification of a warning or alarm

The D/A converter module notifies that a warning or alarm occurs to the master station in the following method.

Item	Description	Reference
Warning flag (RX7)	Turns on when a minor error occurs.	Page 131, Appendix 1.1 (1)
Latest warning code (RWr1)	The error code or alarm code is stored when a minor error occurs.	Page 136, Appendix 2 (2)

(a) Method for clearing a warning or alarm

The method for clearing an error depends on the error type.

Error type		Clearing an error	
Minor error	Warning	A warning is cleared five seconds after the error cause is removed. ^{*1}	
	Alarm ^{*2}	Check code	Turn on Error clear request flag (RYA) or Initial data setting request flag (RY9) after writing a digital value within the setting range.
		Alert occurrence	Turn on Alert output clear request flag (RY1E) or Initial data setting request flag (RY9) after writing a digital value within the setting range.

- *1 A warning is in the following state five seconds after the error cause is removed.
 - Warning flag (RX7) turns off.
 - Latest warning code (RWr1) is cleared.
 - The ERR. LED turns off.
- *2 The alarm is not automatically cleared. Latest warning code (RWr1) is cleared when the other minor errors are cleared in the alarm status.

The warning codes can be checked in the error history on GX Works2. For the error history, refer to the following.

 - Checking by executing a command of the slave station (☞ Page 116, Section 11.1 (1))
 - Error history □ (address: 0A00_H to 0AEF_H) (☞ Page 148, Appendix 3 (14))

Ex. Operation to clear Station number switch changing error (error code: 0940_H)

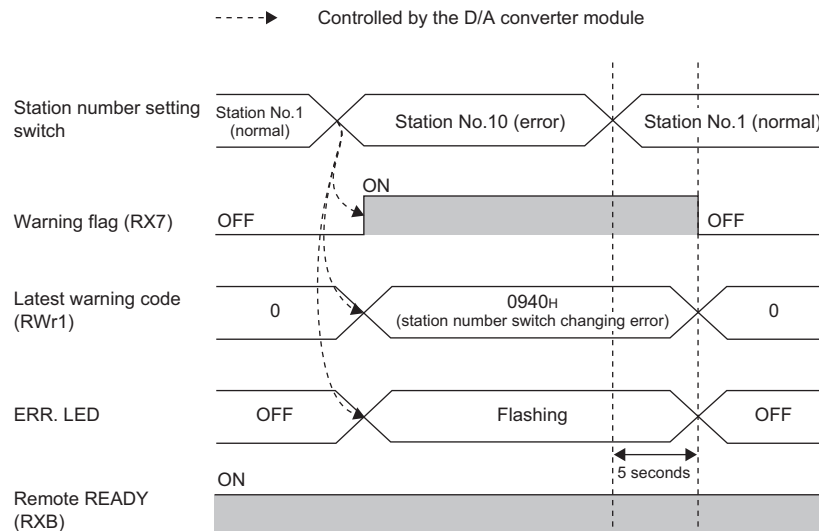

For the method for clearing an alarm, refer to the following.

- Digital Value Range Check Function (☞ Page 89, Section 8.8)
- Alert Output Function (☞ Page 92, Section 8.9)

(3) Method for clearing an error by executing the command of the slave station

The following shows how to clear an error by executing the command of the slave station. Moderate errors and Out-of-range digital value can be cleared.

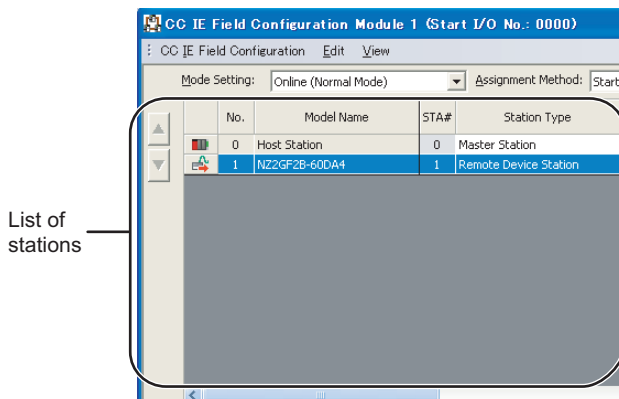

1. Select the D/A converter module in "List of stations" on the "CC IE Field Configuration" window.

2. Open the "Command Execution of Slave Station" window.

[CC IE Field Configuration] ⇨ [Command Execution of Slave Station]

3. Set "Method selection" to "Error clear request" and click the button.

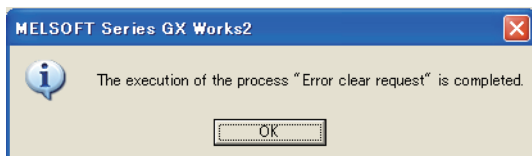
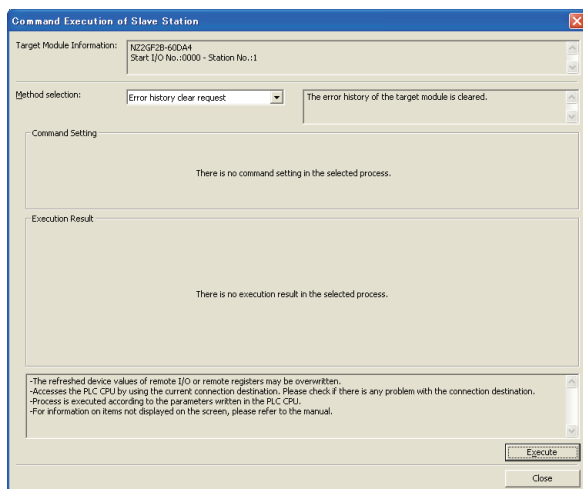

4. When the window shown on the left is displayed, click the button.

5. The error for the D/A converter module is cleared.

8.11 Function at the Extension Module Installation

One extension I/O module can be connected to one D/A converter module.

Remote input signals of the D/A converter module can be assigned to remote output signals of the connected extension output module. In addition, functions unique to the extension I/O module can be used.

Point

- Turn off the D/A converter module before replacing the extension I/O module. If the extension module is removed when the module power supply is on, the error code (1F00_H) is stored to Latest error code (RWr0), Error flag (RXA) turns on, and the ERR. LED turns on. The main module stops its operation.
- After replacing the extension I/O module, write the parameters again.

(1) Functions available with an extension I/O module connected

Function	Reference
External power supply monitoring function	Page 98, Section 8.11 (2)
External signal assignment function	Page 99, Section 8.11 (3)
Digital output HOLD/CLEAR setting function (Named "Output HOLD/CLEAR setting function" in the I/O module manual.)	CC-Link IE Field Network Remote I/O Module User's Manual
Input response time setting function	
Number of ON times integration function	

(2) External power supply monitoring function

Using this function, the D/A converter module monitors the ON/OFF status of the external power supply and shows it with the I/O PW LED on the extension I/O module.

By using External power supply monitor request flag (RY1F), a moderate error is generated when the external power supply is off. Thus, the ON/OFF status of the external power supply is notified and the extension output module can be stopped.

(a) External power supply monitoring function

When the external power supply is turned off with External power supply monitor request flag (RY1F) on, a moderate error occurs. When using this function, check that the external power supply stabilizes before turning on External power supply monitor request flag (RY1F). When turning off the external power supply, turn off External power supply monitor request flag (RY1F) in advance.

(b) Setting and checking the external power supply monitoring function

Item	Description	Reference
External power supply monitor request flag (RY1F)	Set whether to enable or disable the external power supply monitoring function.	Page 135, Appendix 1.2 (5)
External power supply monitor state flag (RX1F)	Indicates whether the external power supply monitoring function is enabled or disabled.	Page 134, Appendix 1.1 (6)

(3) External signal assignment function

Remote output signals of the D/A converter module can be assigned to output signals of the connected extension output module. Error signals can be output to the external from the extension output module at the fixed timing without influence from the sequence scan or link scan.

Target remote input signal of external signal assignment	Buffer memory to be set
Alert output signal (RX1E)	"Alert output signal assignment"
Error flag (RXA)	"Error flag assignment"
Warning flag (RX7)	"Warning flag assignment"

(a) Operation of the external signal assignment function

Ex. When Alert output signal (RX1E) of the D/A converter module is assigned to RY2A of the extension output module

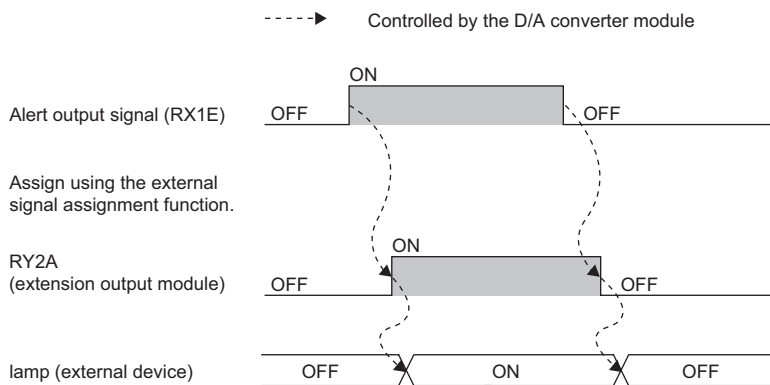
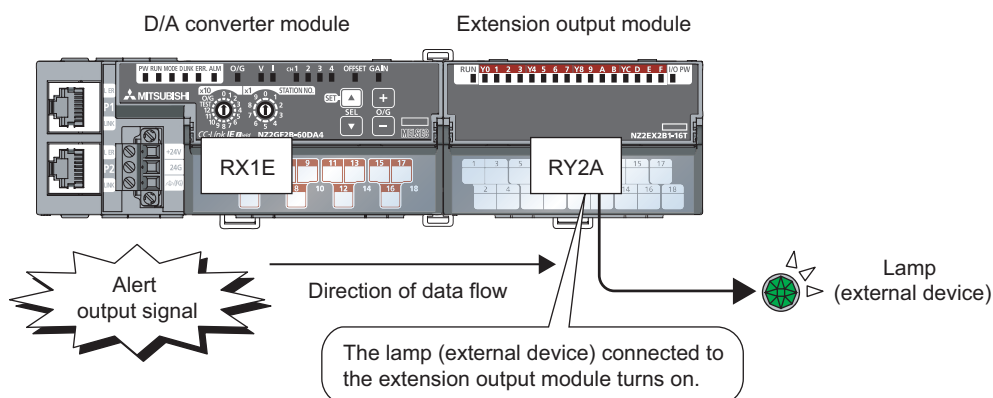

Point

When a remote input signal of the main module is assigned to a remote output signal of the extension output module, the assigned remote output signal cannot be turned on/off or monitored using the program. Turn on/off or monitor the remote input signal before assignment of the main module. (In the above example, turn on/off or monitor Alert output signal (RX1E).)

(4) Setting procedure

Ex. When setting the assignment explained in the previous page

1. Set "Parameter write" for "Method selection".

 "CC IE Field Configuration" window ⇨ Select a D/A converter module in "List of stations" ⇨ [CC IE Field Configuration] ⇨ [Parameter Processing of Slave Station]

2. Set "CH□ D/A conversion enable/disable setting" to "0: Enable".

<input checked="" type="checkbox"/>	<input type="checkbox"/> D/A conversion enable/disable...			
 CH1 D/A conversion enabl...	1: Disable		
 CH2 D/A conversion enabl...	1: Disable		
 CH3 D/A conversion enabl...	1: Disable		
 CH4 D/A conversion enabl...	1: Disable		

3. Set "CH1 Alert output setting" to "0: Enable".

<input checked="" type="checkbox"/>	<input type="checkbox"/> Alert output function			
 CH1 Alert output setting	1: Disable		
 CH1 Alert output upper lim...	0		
 CH1 Alert output lower lim...	0		
 CH2 Alert output setting	1: Disable		

4. Set values for "CH1 Alert output upper limit value" and "CH1 Alert output lower limit value".

<input checked="" type="checkbox"/>	<input type="checkbox"/> Alert output function			
 CH1 Alert output setting	1: Disable		0: Enable
 CH1 Alert output upper lim...	0		16000
 CH1 Alert output lower lim...	0		4000

5. Set 0x002A ("2A" of RY2A) for "Alert output signal assignment".

<input checked="" type="checkbox"/>	<input type="checkbox"/> External signal assignment s...			
 Alert output signal assign...	0xFFFF		0x002A

Point

- Signals other than remote I/O signals assigned to the external module cannot be set with the external signal assignment function.
If the above is set, the error code (017 Δ_H) is stored in Latest error code (RWr0), Error flag (RXA) turns on, and the ERR. LED turns on.
- Multiple remote I/O signals of the main module cannot be assigned to a remote output signal of the extension module.
If the above is set, the error code (0180 $_H$) is stored in Latest error code (RWr0), Error flag (RXA) turns on, and the ERR. LED turns on.
- The external signal assignment function cannot be used together with the digital output HOLD/CLEAR function.
When "Digital output HOLD/CLEAR setting" is set to "1: HOLD", the setting is ignored and the D/A converter module operates with "0: CLEAR" set.

(a) Operation of when an error occurs

The operation of the D/A converter module for an error depends on whether or not the external signal assignment function is used, as show in the following table.

Remote I/O signal		Remote input (RX)		Remote output (RY)			
Digital output HOLD/CLEAR setting function		-		CLEAR		HOLD	
External signal assignment function		Used	Unused	Used	Unused	Used	Unused* ¹
Status of the D/A converter module	Minor error	Same as the normal operation		Same as the normal operation		Same as the normal operation	
	Moderate error	Clear	Clear	Clear	Same as the normal operation	Clear	Same as the normal operation
	Major error	Clear		Clear		Clear	
	Disconnecting or CPU STOP	Clear	Clear	Clear	Same as the normal operation	Hold	Same as the normal operation

*1 When the external signal assignment function is used, the operation of the D/A converter module is the same as that of when the CLEAR is set for the digital output HOLD/CLEAR setting function, even if HOLD is set.

When different types of errors occur, an error is received in the following priority order.

- Major error > Moderate error > Minor error > the error at the time of Disconnecting or CPU STOP

8.12 CC-Link IE Field Network Diagnostic Function

With this function, whether any network error occurs or not can be checked through GX Works2 connected to the CPU module.

(1) How to use

1. Connect GX Works2 to the CPU module.
2. Start CC-Link IE Field Network diagnostics from the menu of GX Works2.

 [Diagnostics] ⇨ [CC IE Field Diagnostics]

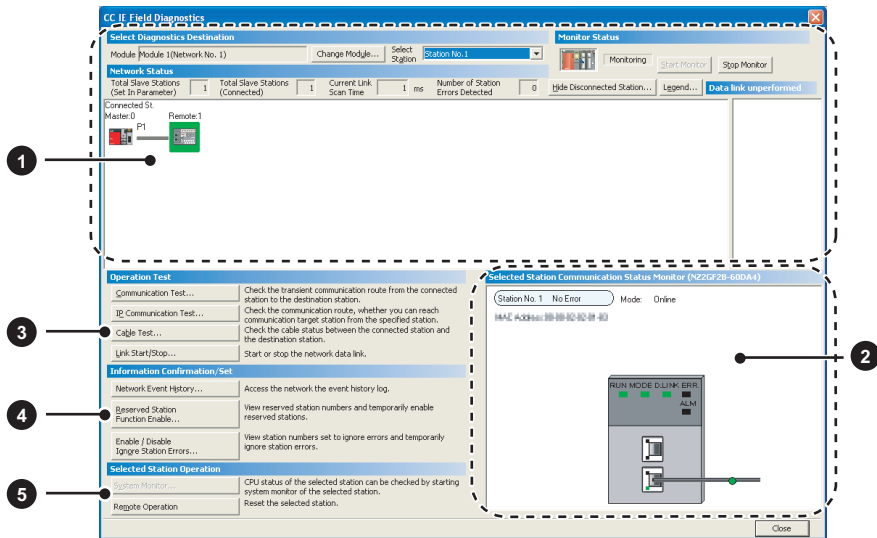

Item to be diagnosed		Description	Reference
①	Display of network configuration diagram and error status	The status of the CC-Link IE Field Network can be checked. When an error or warning for the D/A converter module occurs, the status of the station is displayed on an icon.	User's manual for the master/local module used
②	Display of selected-station status and error details	The communication status of the station selected in "Networks Status" can be checked.*1	
③	Communication Test	The transient communication route and whether the communication is established from the connected station to the destination station can be checked.	
	IP Communication Test	The reaching time and the route of the IP communication from the connected station to the target station can be checked. This function is unavailable for the D/A converter module.	
	Cable Test	The cable status between the connected station and the destination station can be checked.	
	Link Start/Stop	The network data link can be started and stopped.	
④	Network Event History	The history of various events that occurred in the network can be checked.	
	Reserved Station Function Enable	A reservation for a station can be temporarily cancelled, and the cancellation can be disabled. Also, the station numbers for the modules set as reserved stations can be checked on a list.	
	Enable/Disable Ignore Station Errors	A station not set as an error invalid station can be temporarily set as an error invalid station, and the error invalid station setting can be disabled. Also, the station numbers for the modules set as (temporarily) error ignore stations can be checked on a list.	
⑤	System Monitor	The system monitor on the selected station is activated and the status of the module can be checked. This function is unavailable for the D/A converter module.	
	Remote operation	The selected station can be reset through the remote operation.	Page 104, Section 8.12 (1) (a)

*1 "Selected Station Communication Status Monitor", which appears at the bottom right in the window, indicates the communication status of the D/A converter module. For the error and alarm for the D/A converter module, refer to the following.

- Checking for the Error Codes and the Alarm Codes (☞ Page 116, Section 11.1)

(a) Remote operation

1. Select a slave station to be reset and click the  button.

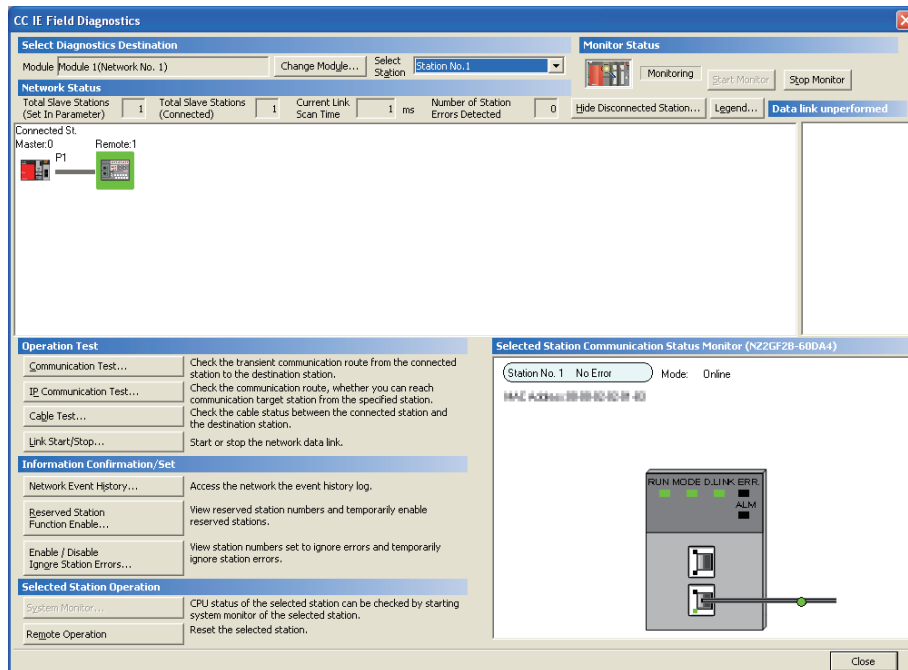

2. Clicking the  button on the following window starts the remote reset.

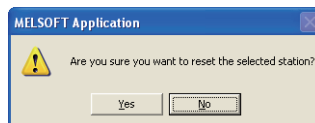

3. Click the  button on the following window.

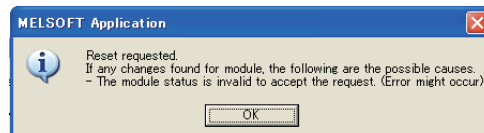

CHAPTER 9 PROGRAMMING

This chapter describes the programming of the D/A converter module.

9.1 Precautions for Programming

This section describes precautions to create CC-Link IE Field Network programs.

(1) Cyclic transmission program

For a cyclic transmission program, interlock with the following link special relay (SB) and link special register (SW).

- Own station data link status (master station) (SB0049)
- Data link status (each station) (SW00B0 to SW00B7)

For the link special relay (SB) and link special register (SW), refer to the following.

 User's manual for the master/local module used

Ex. Interlock example

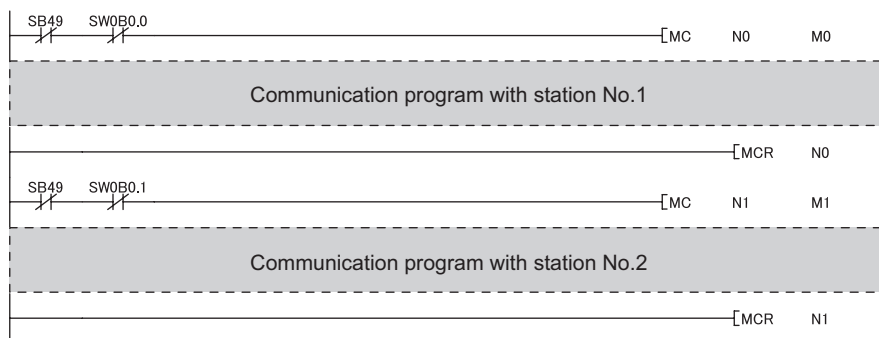

(2) Transient transmission program

For a transient transmission program, interlock with the following link special relay (SB) and link special register (SW).

- Own station baton pass status (master station) (SB0047)
- Baton pass status (each station) (SW00A0 to SW00A7)

For the link special relay (SB) and link special register (SW), refer to the following.

 User's manual for the master/local module used

Ex. Interlock example

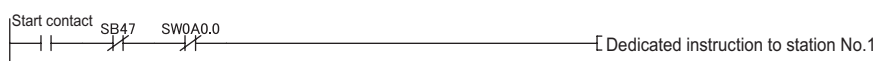

9.2 Procedure for Programming

Create a program to execute D/A conversion, according to the following procedure.

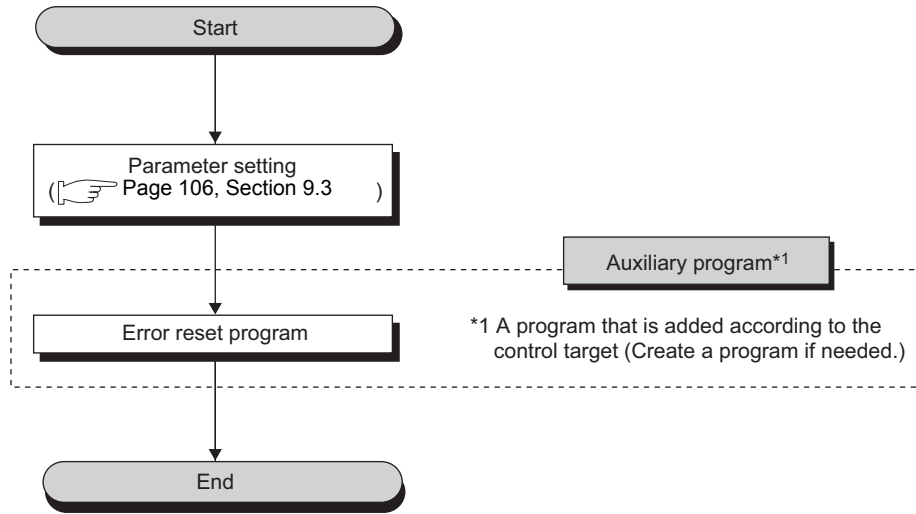

9.3 Program Example

(1) System configuration

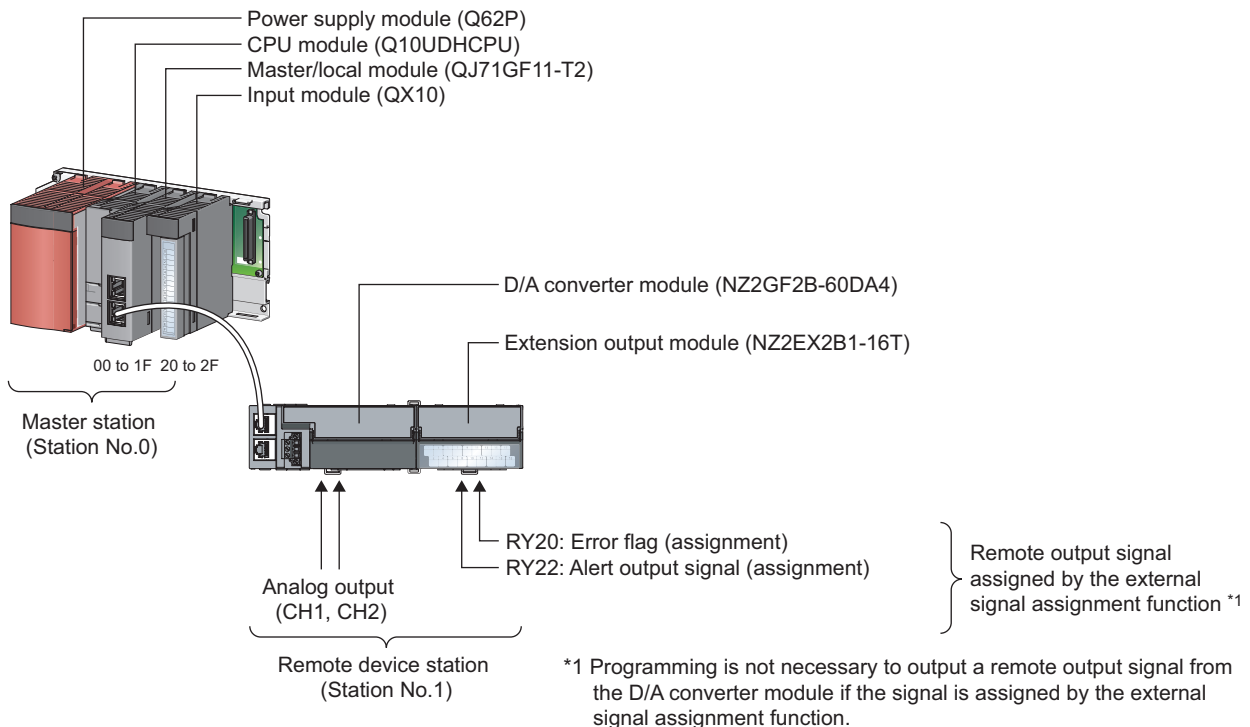

(a) Link device assignment

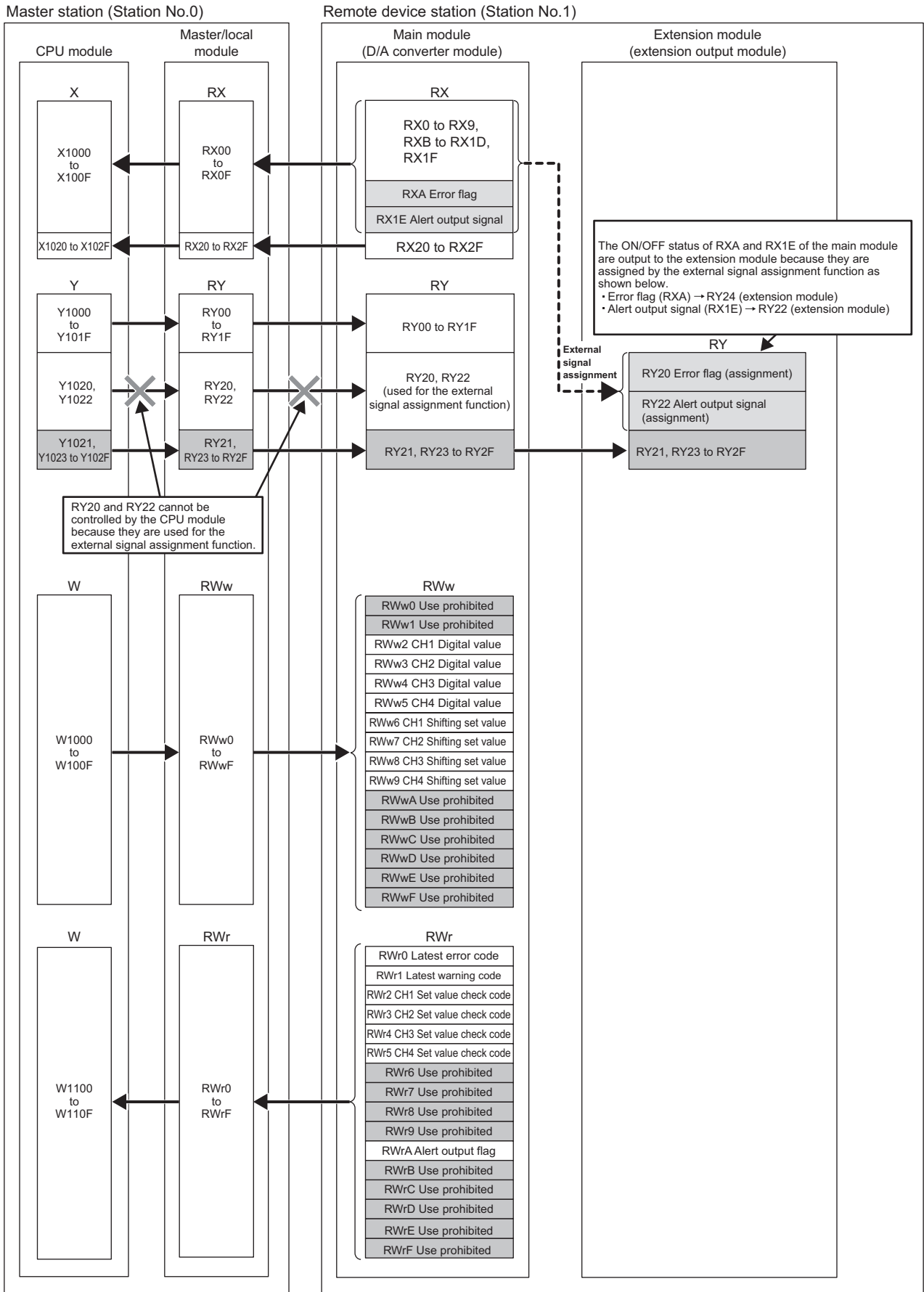

9.3 Program Example

(2) Programming condition

This program enables the D/A conversion in CH1 and CH2 of the D/A converter module and outputs the written digital values in analog.

If an error or alert occurs, a digital signal is output from the extension output module.

(3) Initial setting description

Setting item		Setting value
External signal assignment function	Alert output signal assignment	0x0022
	Error flag assignment	0x0024
D/A conversion enable/disable setting	CH1 D/A conversion enable/disable setting	0: Enable
	CH2 D/A conversion enable/disable setting	0: Enable
Analog HOLD/CLEAR setting	CH1 Analog output HOLD/CLEAR setting	1: HOLD
Alert output function	CH2 Alert output setting	0: Enable
	CH2 Alert output upper limit value	16000
	CH2 Alert output lower limit value	10000
Scaling function	CH1 Scaling enable/disable setting	0: Enable
	CH1 Scaling upper limit value	32000
	CH1 Scaling lower limit value	0

Set the initial values for the parameters other than the above.

(4) Device for user

Device	Description	
X20	Digital value write command	QX10 (X20 to X2F)
X22	Batch analog output enable command	
X24	Alert output clear command	
X26	Error clear command	
X28	Check code clear command	
X1007	Warning flag	NZ2GF2B-60DA4 (X1000 to X101F)
X1009	Initial data setting completed flag	
X100A	Error flag	
X100B	Remote READY	
X101E	Alert output signal	
Y100A	Error clear request flag	NZ2GF2B-60DA4 (Y1000 to Y101F)
Y1010	CH1 Output enable/disable flag	
Y1011	CH2 Output enable/disable flag	
Y101E	Alert output clear request flag	
D2002	CH1 Digital value	
D2003	CH2 Digital value	
D2100	Latest error code	
D2110	Alert output flag	
D2120	Latest warning code	
D2130	CH1 Set value check code	
D2131	CH2 Set value check code	
M100	Communication ready flag (station No.1)	
W1002	CH1 Digital value	Device to be written by link refresh
W1003	CH2 Digital value	
W1100	Latest error code	
W1101	Latest warning code	
W1102	CH1 Set value check code	
W1103	CH2 Set value check code	
W110A	Alert output flag	
SM400	Always ON	
SB49	Own station data link status (master station)	
SWB0.0	Data link status (each station) (station No.1)	
N0	Nesting (station No.1)	

(5) Setting procedure

Connect GX Works2 to the master station to configure the setting.

1. Create a project on GX Works2.

Select "QCPU (Q mode)" for "PLC Series" and select "Q10UDH" for "PLC Type".

 [Project] ⇨ [New]

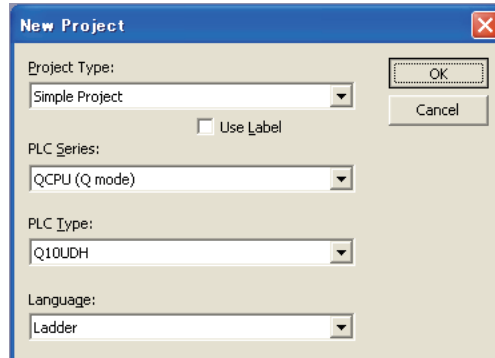

2. Display the network parameter setting window and configure the setting as follows.

 Project window ⇨ [Parameter] ⇨ [Network Parameter] ⇨ [Ethernet/CC IE/MELSECNET]

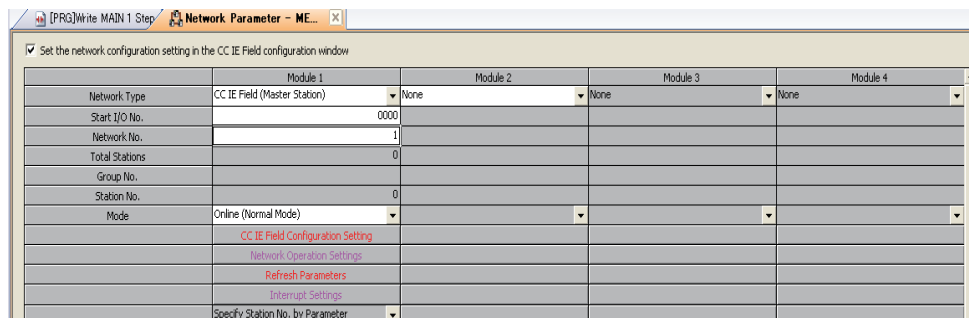

3. Display the "CC IE Field Configuration" window and configure the configuration and station number of the slave station as follows.

 CC IE Field Configuration Setting button

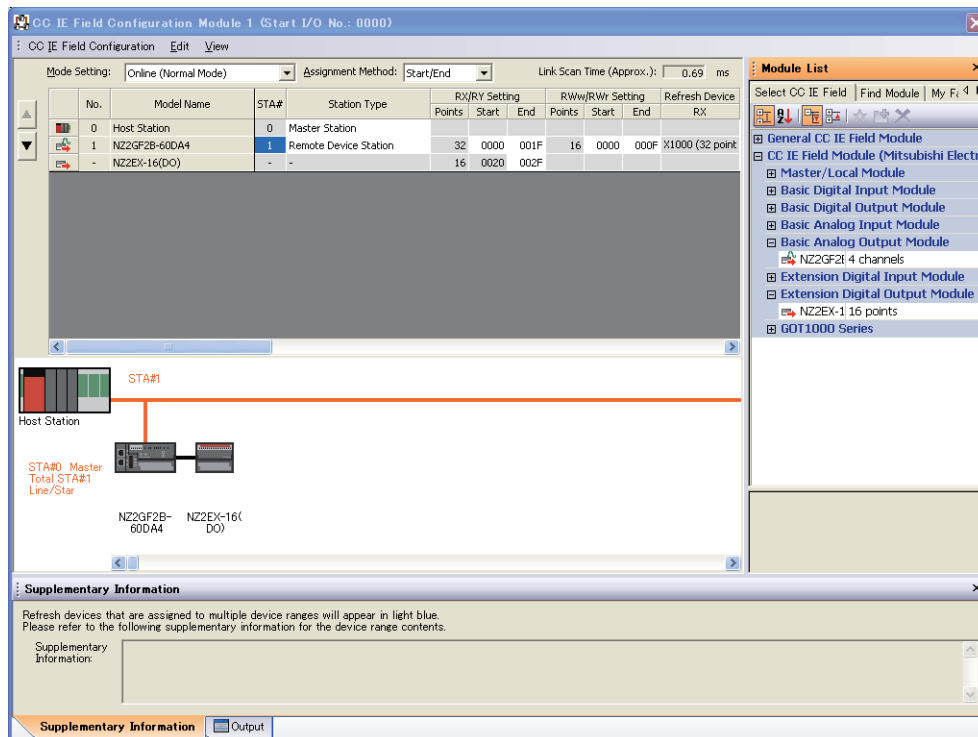

4. Close the "CC IE Field Configuration" window.

[CC IE Field Configuration] ⇨ [Close with Reflecting the Setting]

5. Display the refresh parameter setting window and configure the setting as follows.

 Refresh Parameters button

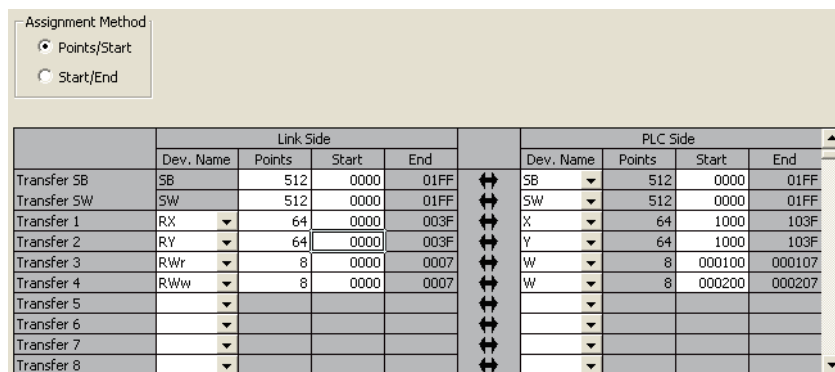

6. Write the set parameter to the CPU module of the master station and reset the CPU module, or turn on from off the power supply.

 [Online] ⇨ [Write to PLC...]

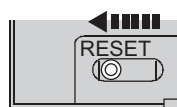

or Power OFF → ON

7. Display the "Parameter Processing of Slave Station" window and change "Method selection" to "Parameter write" to set the following.

Project window ⇨ [Parameter] ⇨ [Network Parameter] ⇨ [Ethernet/CC IE/MELSECNET] ⇨
CC IE Field Configuration Setting button ⇨ Select a D/A converter module in "List of stations" ⇨
 [CC IE Field Configuration] ⇨ [Parameter Processing of Slave Station]

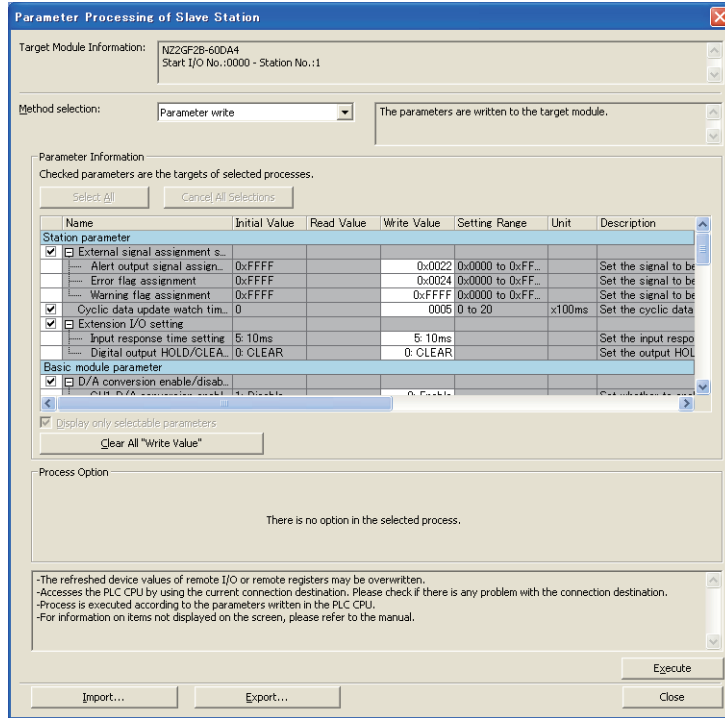

8. Click the Execute button to write the parameter to the D/A converter module.

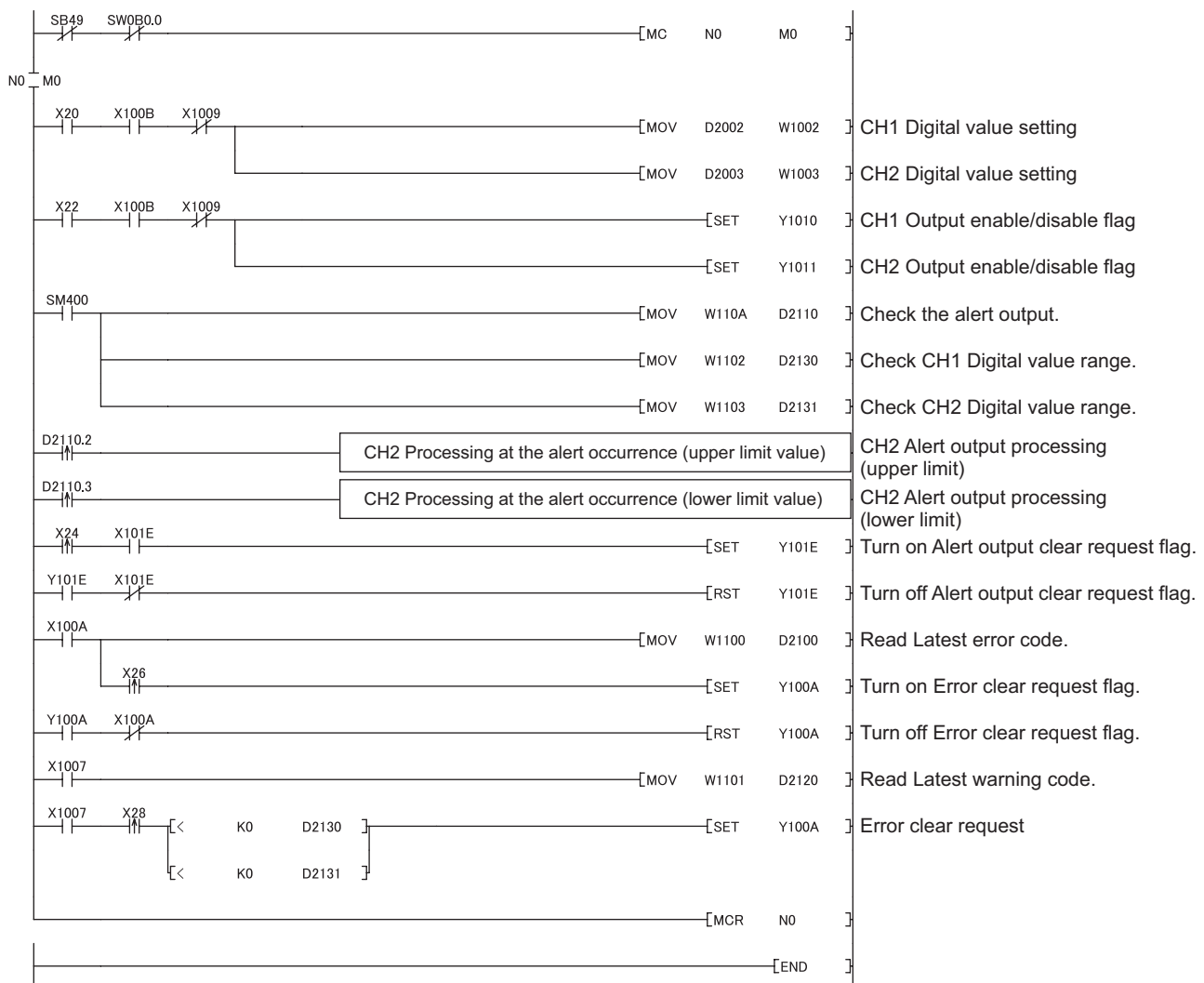
(6) Program example**1. Create the following program with GX Works2.**

- 2. Write the program to the CPU module of the master station and reset the CPU module, or turn on from off the power supply.**

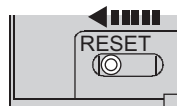

or Power OFF → ON

- 3. Change the status of the CPU module of the master station to RUN.**

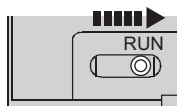

CHAPTER 10 MAINTENANCE AND INSPECTION

The D/A converter module has no special item to be inspected. However, to maintain the best condition of the system, perform the inspection in accordance with the items described in the user's manual of the CPU module used.

Memo

CHAPTER 11 TROUBLESHOOTING

This chapter describes errors that may occur while the D/A converter module is used, and those troubleshooting.

11.1 Checking for the Error Codes and the Alarm Codes

Error codes can be checked by any of the following methods:

- Checking by executing a command of the slave station (☞ Page 116, Section 11.1 (1))
- Checking by Latest error code (RWr0) (☞ Page 118, Section 11.1 (2))
- Checking by Latest warning code (RWr1) (☞ Page 118, Section 11.1 (3))

Alarm codes can be checked by any of the following methods:

- Checking by executing a command of the slave station (☞ Page 116, Section 11.1 (1))
- Checking by Latest warning code (RWr1) (☞ Page 118, Section 11.1 (3))

(1) Checking by executing a command of the slave station

This section describes how to check the errors by executing a command of the slave station.

1. Select the D/A converter module in "List of stations" on the "CC IE Field Configuration" window.

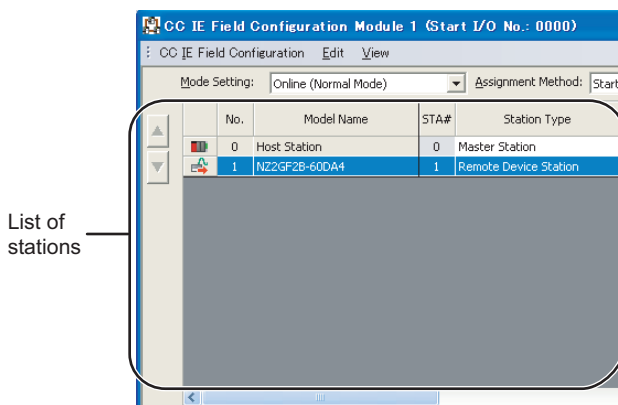

2. Open the "Command Execution of Slave Station" window.

☞ [CC IE Field Configuration] ⇒ [Command Execution of Slave Station]

3. Set "Method selection" to "Error history read" and click the **Execute** button.

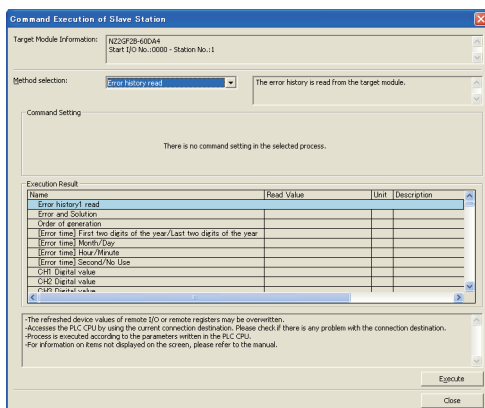

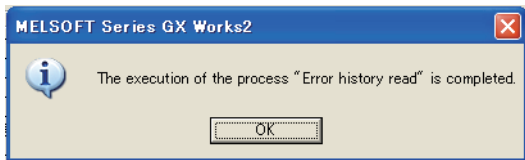

4. When the window shown on the left is displayed, click the **OK** button.

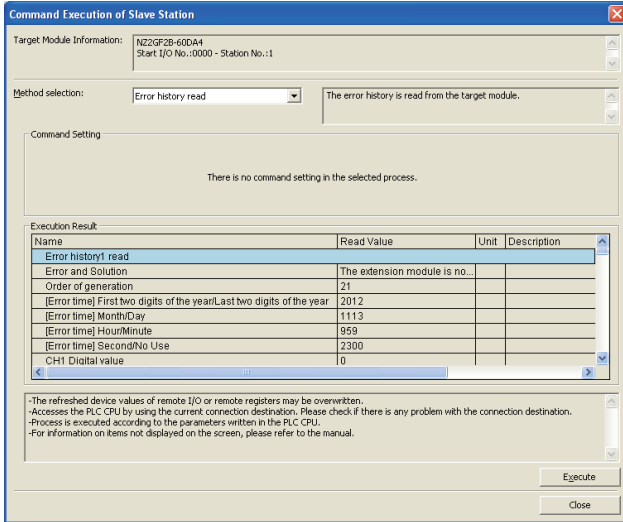

5. The error history of the D/A converter module is displayed in "Execution Result".

Item	Contents
Error code	The action for the error is displayed.
Order of generation	The order of error occurrence is displayed.
[Error time] First two digits of the year/Last two digits of the year	The date and time of error occurrence is displayed.
[Error time] Month/Day	(When the tens place of Month, Hour and Second is "0", the date and time are displayed without "0".)
[Error time] Hour/Minute	
[Error time] Second/No Use	
CH1 Digital value	
CH2 Digital value	The value of CH□ Digital value (RWw2 to RWw5) when an error occurs is stored.
CH3 Digital value	
CH4 Digital value	

Point

- The error history registers 15 errors at a maximum. If 16 or more errors occur, errors are deleted from the oldest.
- If the same error occurs continuously, the error that occurred first is stored to the error history.
- Even after the power of the module is turned off and on, the error history remains.
- To initialize the error history, set "Method selection" to "Error history clear request" on the "Command Execution of Slave Station" window and click the **Execute** button.

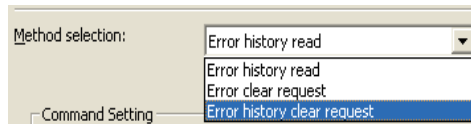

(2) Checking by Latest error code (RWr0)

Check the latest error code with the buffer memory of the master/local module.

 [Online] ⇨ [Monitor] ⇨ [Device/Buffer Memory Batch]

Ex. When the refresh target device for Latest error code (RWr0) is W1100

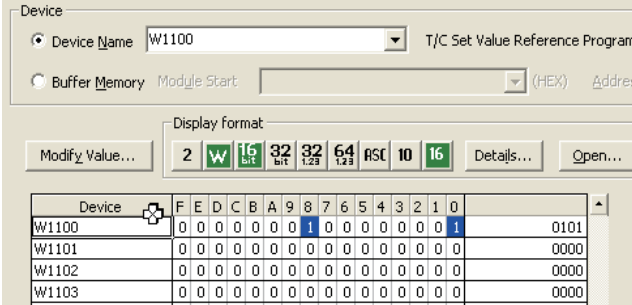

Device	F	E	D	C	B	A	9	8	7	6	5	4	3	2	1	0	
W1100	0	0	0	0	0	0	0	1	0	0	0	0	0	0	0	1	0101
W1101	0	0	0	0	0	0	0	0	0	0	0	0	0	0	0	0	0000
W1102	0	0	0	0	0	0	0	0	0	0	0	0	0	0	0	0	0000
W1103	0	0	0	0	0	0	0	0	0	0	0	0	0	0	0	0	0000

(3) Checking by Latest warning code (RWr1)

Check the latest warning code with the buffer memory of the master/local module.

 [Online] ⇨ [Monitor] ⇨ [Device/Buffer Memory Batch]

Ex. When the refresh target device for Latest warning code (RWr1) is W1101

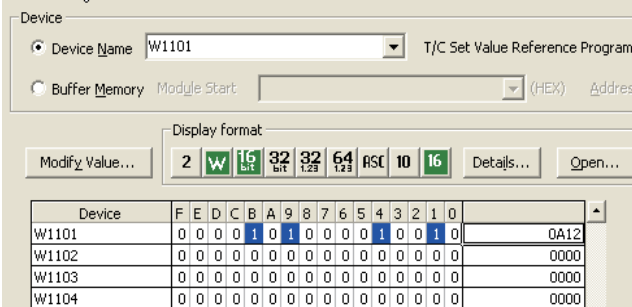

Device	F	E	D	C	B	A	9	8	7	6	5	4	3	2	1	0	
W1101	0	0	0	0	1	0	1	0	0	0	0	1	0	0	1	0	0A12
W1102	0	0	0	0	0	0	0	0	0	0	0	0	0	0	0	0	0000
W1103	0	0	0	0	0	0	0	0	0	0	0	0	0	0	0	0	0000
W1104	0	0	0	0	0	0	0	0	0	0	0	0	0	0	0	0	0000

11.2 Error Code List

This section describes error codes.

Error codes are classified by error number as follows.

Error code	Classification	Reference
0000 _H to 3FFF _H , D529 _H , CD52B _H	D/A converter module error	Page 119, Section 11.2 (1)
D000 _H to DFFF _H (D529 _H and D52B _H excluded)	CC-Link IE Field Network error (communication system error)	Page 123, Section 11.2 (2)

(1) Error code list (0000_H to 3FFF_H D529_H D52B_H)

The errors are classified into the following three types.

Classification	Description
Major error	An error that cannot be recovered. The RUN LED turns off.
Moderate error	An error where the module cannot continue to operate. The ERR. LED turns on.
Minor error	An error where the module can continue to operate. The ERR. LED flashes.

If an error occurs, check that the D LINK LED is on. Then take corrective actions as listed below.

Error code (hexadecimal)	Classification	Error name	Description and cause	Action
0010 _H	Major error	Hardware failure	Module hardware error	Turn off and on the module. If this error persists, the module may be in failure. Please consult your local Mitsubishi representative.
010 □ _H	Moderate error	Range setting outside the range	The value set in Range setting (address: 0103 _H) is outside the range. □ represents the channel number mistakenly set.	Set the value of Range setting (address: 0103 _H) within the allowable range.
0110 _H *1	Moderate error	Non-volatile memory data error (module working information)	The non-volatile memory data are abnormal.	To recover from the error, use the module operation information initialization command. If an error occurs, please consult your local Mitsubishi representative.
0120 _H *1	Moderate error	User range data damaged (The channel cannot be identified.)	The value set in the offset/gain setting is invalid. The channel where the error has occurred cannot be identified.	Start over the offset/gain setting of all channels where the user range setting is used. If an error occurs, please consult your local Mitsubishi representative.

Error code (hexadecimal)	Classification	Error name	Description and cause	Action
0130 _H	Moderate error	Non-volatile memory data error (parameter)	The parameter data stored in the non-volatile memory are abnormal.	<ul style="list-style-type: none"> Set no request (0), request (1), and no request (0) in Parameter information clear request (address: 1002H) and set the parameters of the non-volatile memory to default. Set the parameters again. Take measures against noise with a shielded cable for connection. If this error persists, the module may be in failure. Please consult your local Mitsubishi representative.
0140 _H	Minor error	Non-volatile memory data error (error history)	The error history data stored in the non-volatile memory are abnormal.	<ul style="list-style-type: none"> The module will be automatically recovered immediately after the error occurs. Note that the error history of the errors that have occurred will be lost. Take measures against noise with a shielded cable for connection. If this error persists, the module may be in failure. Please consult your local Mitsubishi representative.
0160 _H	Minor error	Remote buffer memory access error	A buffer memory area other than the remote buffer memory areas has been accessed using the REMFR/REMTO instruction.	Correct the setting data of the REMFR/REMTO instruction to access the remote buffer memory.
017 Δ _H	Moderate error	External signal assignment setting error	<p>An address other than those assigned to the extension I/O module for the external signal assignment function has been set.</p> <p>Δ represents one of the following error types.</p> <p>2: Alert output function 3: Error output 4: Warning output</p>	Set an address that has been assigned to the extension I/O module for the external signal assignment function.
0180 _H	Moderate error	Same address for the external signal assignment function	The same address has been set in multiple extension output modules for the external signal assignment function.	Set a unique address.
040 \square _H ^{*1}	Moderate error	Offset/gain setting value inverted	<p>The user range setting value has been set to a value where the offset value is equal to or greater than the gain value.</p> <p>\square represents the channel number where an error has occurred.</p>	Correct the setting so that the offset value is smaller than the gain value.
060 \square _H ^{*1}	Minor error	Digital value outside the range	<p>The value set in CH\square Digital value (RWw2 to RWw5) is outside the range.</p> <p>\square represents the channel number where an error has occurred.</p>	Set the value of CH \square Digital value (RWw2 to RWw5) within the allowable range.

Error code (hexadecimal)	Classification	Error name	Description and cause	Action
062 □ _H *1	Moderate error	Alert output upper/lower limit value inverted	The alert output lower limit value has been set equal to or greater than the alert output upper limit value in CH1 Alert output upper limit value (address: 0106 _H) to CH4 Alert output lower limit value (address: 010D _H). □ represents the channel number where an error has occurred.	Correct the settings of CH1 Alert output upper limit value (address: 0106 _H) to CH4 Alert output lower limit value (address: 010D _H) so that the alert output lower limit value is smaller than the alert output upper limit value.
090 □ _H *1	Moderate error	Scaling setting outside the range	The values set in CH1 Scaling lower limit value (address: 010F _H) to CH4 Scaling upper limit value (address: 0116 _H) are outside the range of -32000 to 32000. □ represents the channel number where an error has occurred.	Set a value within the range of -32000 to 32000 in CH1 Scaling lower limit value (address: 010F _H) to CH4 Scaling upper limit value (address: 0116 _H).
091 □ _H *1	Moderate error	Scaling upper/lower limit value inverted	The scaling lower limit value has been set equal to or greater than the scaling upper limit value in CH1 Scaling lower limit value (address: 010F _H) to CH4 Scaling upper limit value (address: 0116 _H). □ represents the channel number where an error has occurred.	Correct the settings of CH1 Scaling lower limit value (address: 010F _H) to CH4 Scaling upper limit value (address: 0116 _H) so that the scaling lower limit value is smaller than the scaling upper limit value.
0930 _H	Moderate error	Cyclic data update watch time setting outside the range	The value set in Cyclic data update watch time (address: 0007 _H) is outside the range of 0 to 20.	Set a value within the range of 0 to 20 in Cyclic data update watch time (address: 0007 _H).
0940 _H	Minor error	Station number switch changed error	The station number switch setting has been changed while the module power is on.	While the module power is on, set the switch again to the station number that has been set before.
0950 _H	Moderate error	Clock data outside the range	The clock data acquired from the CPU module is invalid.	There may be an influence from noise or a hardware error. If the same error occurs again even after measures have been taken against noise, please consult your local Mitsubishi representative.
0960 _H	Major error	Network No. changed through the network	The network number has been changed through the network.	Take measures against noise and reset the module. If the same error occurs again, the hardware of the module may be in failure. Please consult your local Mitsubishi representative.
0970 _H	Major error	Station No. changed through the network	The station number has been changed through the network.	Take measures against noise and reset the module. If the same error occurs again, the hardware of the module may be in failure. Please consult your local Mitsubishi representative.

Error code (hexadecimal)	Classification	Error name	Description and cause	Action
1F00 _H	Major error	Extension module connected error	An extension module that is not supported has been connected.	Remove an extension module that is not supported.
1F20 _H	Moderate error	External power supply OFF error	The external power supply of the extension output module is off with the external power supply monitoring function enabled.	<ul style="list-style-type: none"> • Check the external power supply status of the extension output module. • If an error occurs when the system is started or stopped, correct the timing to enable the external power supply monitoring function.
1F30 _H	Moderate error	Extension module parameter error	The parameter of the model name that is different from the model name of the connected extension module has been reflected.	Set the same type and number of points in Extension module identification code (address: 0200 _H) as those of the connected extension module.
1F40 _H	Moderate error	Input response time setting error	000b or 001b has been set in the low 3 bits of Input response setting (address: 0010 _H).	Set a value other than 000b and 001b to the low 3 bits of Input response setting (address: 0010 _H).
D529 _H	Major error	Communication error 1	The communication LSI is in failure.	<ul style="list-style-type: none"> • A malfunction may have occurred due to noise or others. Check the cable distance or grounding condition of each device. Then take measures against noise. • Execute a unit test for the module. If the same error occurs again, the hardware of the module may be in failure. Please consult your local Mitsubishi representative.
D52B _H	Major error	Communication error 2		

*1 Set a value within the allowable range. Then perform one of the following operations to clear the error.



- Turn on and off Error clear request flag (RYA).
- Turn on and off Initial data setting request flag (RY9).

Point

When multiple errors occur, only the latest error code is stored in Error code (RWr0) or Warning code (RWr1).

The errors that have occurred before can be checked with the error history of GX Works2.

For error history, refer to the following.

- Checking by executing a command of the slave station ( Page 116, Section 11.1 (1))
- Error history data \square (address: 0A00_H to 0AEF_H) ( Page 148, Appendix 3 (14))

(2) Error code list (D000_H to DFFF_H (D529_H and D52B_H excluded))

When an error occurs, the ERR. LED does not turn on. The D LINK LED flashes or turns off.

Troubleshoot the problem with the CC-Link IE Field Network diagnostics. (☞ Page 102, Section 8.12)

Error code (hexadecimal)	Error name	Description and cause	Action
D0E0 _H	Station type mismatch	The network parameter is incorrect or outside the range.	In the network configuration settings of the master station, change the station type to that of the remote device station.
D0E1 _H	Own station reserved	The network parameter is incorrect or outside the range.	<ul style="list-style-type: none"> In the network configuration settings of the master station, cancel the reserved station setting. Change the station number of the module to a station number that is not reserved.
D0E2 _H	Station No. already in use (own station)	The network parameter is incorrect or outside the range.	<ul style="list-style-type: none"> Set a unique station number. After taking the above action, turn off and on or reset all the stations where this error has been detected.
D0E3 _H	Own station No. out of range	The network parameter is incorrect or outside the range.	Add the station information of the module in the network configuration settings of the master station.
D217 _H	Transient data command error	The transient data request command is incorrect.	Correct the request command at the request source, and retry the operation.
D2A0 _H	Receive buffer full	The target station is overloaded and cannot receive transient data.	<ul style="list-style-type: none"> Check the network status using the CC-Link IE Field Network diagnostics of GX Works2. When the target station is overloaded and cannot receive transient data, send the data to the target station after a while.
D2A3 _H	Transient data length error	The received transient data is incorrect.	Correct the number of data (frame length) at the request source, and retry the operation.
D72A _H	Station number switch out of range (a value other than 1 to 120)	A station number out of range has been set.	Set the station number within the allowable range.
DF01 _H	Transient data divided error	The divided transient data have been received.	Set the transient data size within the range that can be handled by the module. Then send the transient data that is not divided.

Point

When multiple errors occur, only the latest error code is stored in Error code (RWr0) or Warning code (RWr1).

The errors that have occurred before can be checked with the error history of GX Works2.

For error history, refer to the following.

- Checking by executing a command of the slave station (☞ Page 116, Section 11.1 (1))
- Error history data □ (address: 0A00_H to 0AEF_H) (☞ Page 148, Appendix 3 (14))

11.3 Alarm Code List

This section lists alarm codes.

Alarm code (hexadecimal)	Category	Name	Description and cause of alarm	Action
0A△□ _H	Minor error	Alert occurrence	An alert is occurring. The channel where the alert has occurred fits in □. A value fits in △ indicates that the alarm status is as follows: 0: Upper limit of an alert 1: Lower limit of an alert	Set again the digital value within the setting range, and turn on and off Alert output clear request flag (RY1E).

11.4 Checking the LEDs

This section describes how to troubleshoot the system by the LEDs.

(1) When the PW LED does not turn on

Check item	Action
Is any LED other than the PW LED turned on?	When any LED other than the PW LED turns on, the possible cause is a hardware failure. Please consult your local Mitsubishi representative.
Is the module power supply (24VDC) wired?	Wire the module power supply (24VDC).
Is the module power supply (24VDC) turned on?	Turn on the module power supply (24VDC).
Is the voltage of the module power supply (24VDC) within the specified range?	Set the voltage value within the performance specifications.

(2) When the RUN LED does not turn on

Check item	Action
Does the voltage of the module power supplied externally reach to the voltage of the performance specifications?	Check that module power supply voltage is within the range of performance specifications.
Does any hardware error occur?	<p>(☞ Page 25, Section 3.2) After the check, power on the module.</p> <p>If the RUN LED does not turn on even after the module power supply is turned from off to on, the possible cause is a module failure. Please consult your local Mitsubishi representative.</p>



(3) When the MODE LED flashes

Check item	Action
Is the D/A converter module in execution of the unit test?	<p>When the D/A converter module is in execution of the unit test, the D LINK LED turns on after the unit test is completed. Take corrective action according to the result of the unit test.</p> <p>(☞ Page 128, Section 11.5)</p>

(4) When the MODE LED turns off

Check item	Action
Is the D/A converter module in the offset/gain setting mode?	When the D/A converter module is in the offset/gain setting, change the mode to the normal mode after the offset/gain setting is completed.
Does any hardware error occur?	If the MODE LED does not turn on even after the module power supply is turned on from off, the possible cause is a hardware failure. Please consult your local Mitsubishi representative.



(5) When the D LINK LED turns off

Check item	Action
Does the own station in network operate normally?	Connect GX Works2 to the master station, and check if the own station is performing data link by CC-Link IE Field Network diagnostics. ( User's manual for the master/local module used)
Are 1000BASE-T-compliant Ethernet cables used?	Replace the cable with a 1000BASE-T-compliant Ethernet cable. ( User's manual for the master/local module used)
Is the station-to-station distance 100m or less?	Change the station-to-station distance to 100m or less.
Does the cabling condition (bend radius) meet the specifications?	Refer to the manual for the Ethernet cable used, and correct the bend radius.
Is any Ethernet cable disconnected?	Replace the Ethernet cable.
Do other stations connected to the D/A converter module normally operate?	Check if the power supplies of the other stations are turned on.
Does the switching hub normally operate?	<ul style="list-style-type: none"> • Check if a 1000BASE-T-compliant switching hub is used. ( User's manual for the master/local module used) • Check if the power supply of the switching hub is turned on.
Is the station number of the D/A converter module duplicated with any of other stations?	Two or more duplicated stations exist. Change the setting so that all the station numbers differ.

(6) When the D LINK LED flashes

Check item	Action
Does the station number setting of the D/A converter module match the station number of the D/A converter module set in the network configuration settings of the master station or in the CC IE Field configuration?	Match the station number of the D/A converter module with the station number set in the network configuration settings of the master station or in the CC IE Field configuration.
Is the station type remote device station?	Change the station type of the module to the remote device station in the network configuration settings of the master station.
Is the D/A converter module a reserved station?	Change the setting of reserved/ignored error station to other than the reserved station in the network configuration settings of the master station.
Is stop of the data link checked through CC-Link IE Field Network diagnostics?	Check the link status through CC-Link IE Field Network diagnostics and start the link when the data link is stopped.
Is the station number setting switch set to other than 1 to 120?	The setting range for the station number setting switch is 1 to 120. Set the number between 1 and 120.

(7) When the L ER LED turns on

Check item	Action
Are Ethernet cables normal?	<ul style="list-style-type: none"> • Check if 1000BASE-T-compliant Ethernet cables are used. ( User's manual for the master/local module used) • Check if the station-to-station distance is 100m or less. • Check if the Ethernet cables are not disconnected.
Does the switching hub normally operate?	<ul style="list-style-type: none"> • Check if a 1000BASE-T-compliant switching hub is used. ( User's manual for the master/local module used) • Check if the power supply of the switching hub is turned on.
Do other stations connected to the D/A converter module normally operate?	Check if the power supplies of the other stations are turned on.
Is the mode of the module on the master station set to Online?	Change the mode of the module to Online.
Is there any noise affecting the system?	Check the wiring condition of the Ethernet cables.
Is the loopback function enabled for the master station?	When the loopback function is enabled, check if the ring topology is correctly configured for the port where the L ER LED is on. ( User's manual for the master/local module used)

(8) When the LINK LED turns off

Check item	Action
Are Ethernet cables normal?	<ul style="list-style-type: none"> • Check if 1000BASE-T-compliant Ethernet cables are used. ( User's manual for the master/local module used) • Check if the station-to-station distance is 100m or less. • Check if the Ethernet cables are not disconnected.
Do the switching hub and other stations normally operate?	Check if the power supplies of the switching hub and other stations are turned on.

(9) When the ERR. LED turns on

Check item	Action
Does any error occur?	Identify the error cause of the D/A converter module and take corrective action with GX Works2.

(10)When the ALM LED turns on

Check item	Action
Is any alert output?	Check Alert output flag (RWrA).

11.5 Unit Test

Run a unit test to check if there is any abnormality in the D/A converter module.

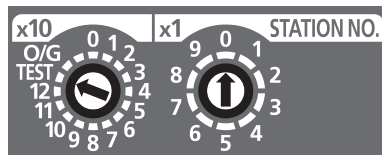
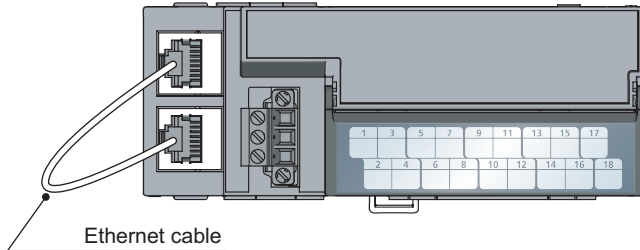

When completed



When failed



1. Power off the module.
2. Connect the PORT1 and PORT2 of the D/A converter module with an Ethernet cable.

3. Set the station number setting switch as follows.

- x10: TEST
- x1: 0

4. Power on the module.

5. Unit test begins.

The MODE LED flashes while the unit test is executed.

6. The MODE LED turns off when the unit test is completed.

- When completed

The ERR. LED does not turn on, but remains off.

- When failed

The ERR. LED turns on.

If the test fails, replace the Ethernet cable and run the test again. If the test fails again, it may be due to a hardware failure in the D/A converter module. Please consult your local Mitsubishi representative.

Remark

When unit test fails, the error details can be checked in the error history in GX Works2.

To check the error history with GX Works2, set the station number of the D/A converter module and connect the module to the master station with an Ethernet cable.

For the error history, refer to the following.

- Checking by executing a command of the slave station (☞ Page 116, Section 11.1 (1))
- Error history□ (address: 0A00_H to 0AEF_H) (☞ Page 148, Appendix 3 (14))

11.6 Troubleshooting for Each Phenomenon

This section describes troubleshooting for each phenomenon.

Perform troubleshooting for each phenomenon when the D/A converter module does not operate properly with no error. When an error occurs in the D/A converter module, identify the error cause with GX Works2.

(1) When the analog output value is not output

Check item	Action
Is there any problem with wiring, such as off or disconnection of analog signal lines?	Check the faulty area by checking signal line visually or conductively.
Is the CPU module in the STOP status?	Change the status of the CPU module to RUN.
Is the offset/gain setting correct?	Check if the offset/gain setting is correct. When the user range setting is selected, change the output range to the factory default setting. Then check if the D/A conversion is executed. If the D/A conversion is properly executed, configure the offset/gain setting again.
Is the output range setting correct?	Check Range setting (address: 0103 _H) with GX Works2 or the dedicated instruction. When the output range setting is wrong, set the range again with the program or the parameter setting.
Is D/A conversion disabled for the channels where the analog value is to be output?	Check D/A conversion enable/disable setting (address: 0102 _H) with GX Works2 or the dedicated instruction. Then, set the D/A conversion enable with the program or the parameter setting.
Is CH□ Output enable/disable flag (RY10 to RY13) set to OFF for the channels where the analog value is to be output?	Check the setting for CH□ Output enable/disable flag (RY10 to RY13) on the monitor of GX Works2. When CH□ Output enable/disable flag (RY10 to RY13) is off, check the program again.
Is a digital value written to the channel to output the analog value?	Check the setting for CH□ Digital value (RWw2 to RWw5) on the monitor of GX Works2.
Is Initial data setting request flag (RY9) executed?	Check if the analog value is output properly after turning on and off Initial data setting request flag (RY9) in GX Works2. When the output is performed properly, check the program again.

Point

If the analog output value cannot be output even after the above actions are taken, the D/A converter module may be failed. Please consult your local Mitsubishi representative.

(2) When the analog output value is not held

Check item	Action
Is the setting for the analog output HOLD/CLEAR function correct?	Set HOLD for the analog output HOLD/CLEAR function using GX Works2. Also, check the setting value for Analog output HOLD/CLEAR setting (address: 0104 _H).

(3) When the ON/OFF status of the remote output (RY) set in the external signal assignment function does not match the signal of the assigned function.

Check item	Action
Is the setting of the external signal assignment function correct?	Check that the following settings are not used in the external signal assignment function. <ul style="list-style-type: none">• Alert output signal assignment (address: 0004_H) (☞ Page 140, Appendix 3 (1))• Error flag assignment (address: 0005_H) (☞ Page 141, Appendix 3 (2))• Warning flag assignment (address: 0006_H) (☞ Page 142, Appendix 3 (3))

APPENDICES

Appendix 1 Details of Remote I/O Signals

This section describes the details of remote I/O signals assigned to the master/local module.

The assignment of each device number is for the case when the remote I/O signals of the main module are assigned as follows.

- Remote input signal: RX0 to RX1F
- Remote output signal: RY0 to RY1F

Appendix 1.1 Remote input signals

(1) Warning flag (RX7)

This signal turns on when a minor error occurs.

Five seconds after the cause of the minor error is eliminated, the value in Latest warning code (RWr1) is cleared automatically (0000_H is stored) and Warning flag (RX7) turns off.

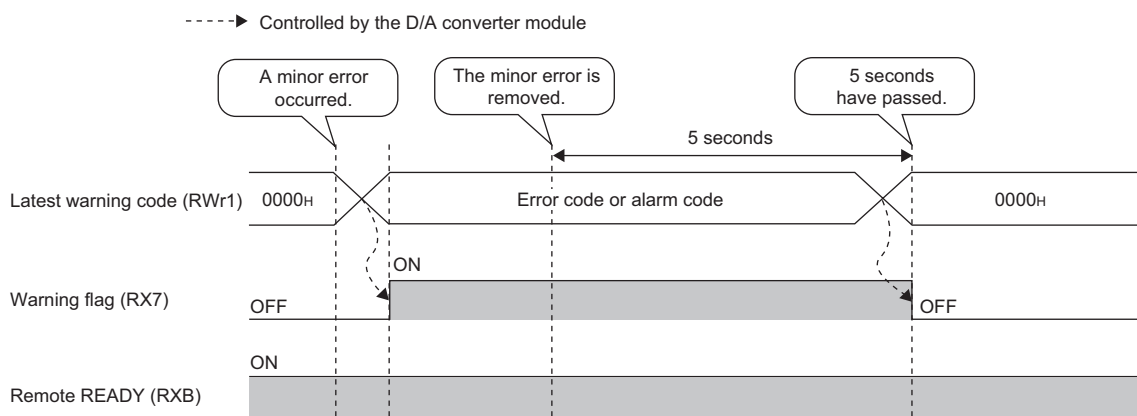

(2) Initial data setting completed flag (RX9)

Turn on Initial data setting request flag (RY9) after writing parameter data to the remote buffer memory with the REMTO instruction.

This signal turns on when the operating condition is changed.

When the following settings are changed, the signal is used as an interlock condition to turn Initial data setting request flag (RY9) on and off.

- Alert output signal assignment (address: 0004_H)
- Error flag assignment (address: 0005_H)
- Warning flag assignment (address: 0006_H)
- Cyclic data update watch time setting (address: 0007_H)
- Input response time setting (address: 0010_H)
- Digital output HOLD/CLEAR setting (address: 0011_H)
- D/A conversion enable/disable setting (address: 0102_H)
- Range setting (address: 0103_H)
- Analog output HOLD/CLEAR setting (address: 0104_H)
- Alert output setting (address: 0105_H)
- CH□ Alert output upper limit value (address: 0106_H, 0108_H, 010A_H, 010C_H)
- CH□ Alert output lower limit value (address: 0107_H, 0109_H, 010B_H, 010D_H)
- Scaling enable/disable setting (address: 010E_H)
- CH□ Scaling lower limit value (address: 010F_H, 0111_H, 0113_H, 0115_H)
- CH□ Scaling upper limit value (address: 0110_H, 0112_H, 0114_H, 0116_H)

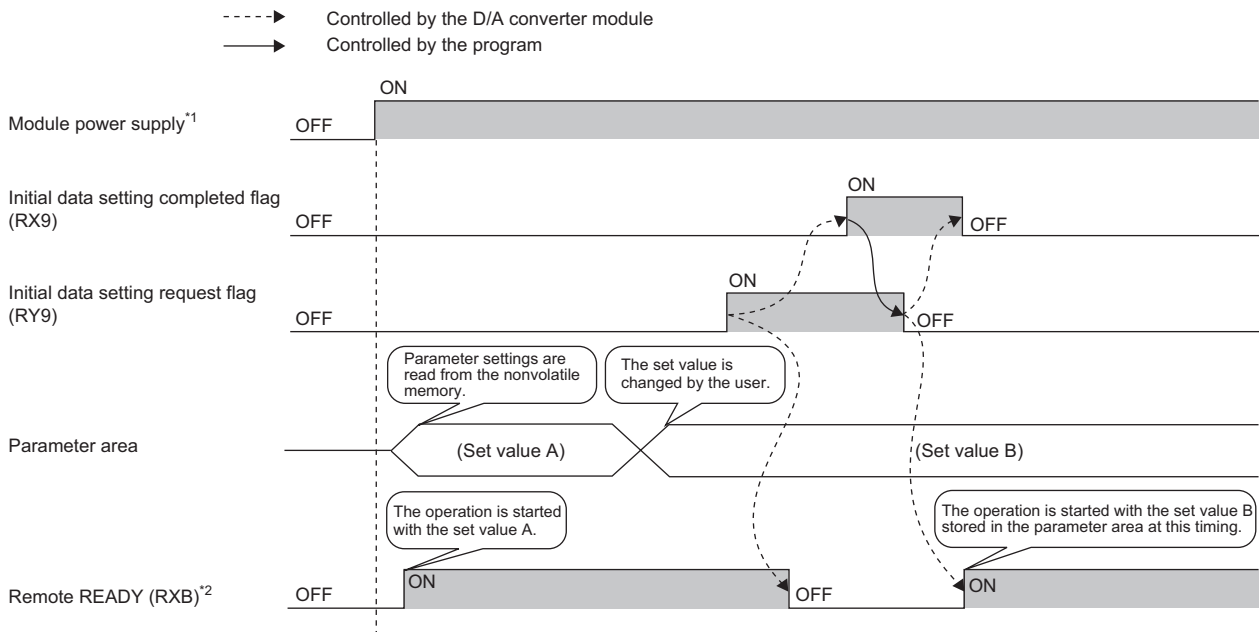

*1 When data link is started at turning on the module power supply

*2 Check that Remote READY (RXB) is turned on, and then start the control when turning on and off Initial data setting request flag (RY9).

(3) Error flag (RXA)

This signal turns on when a moderate or major error occurs.

To clear Latest error code (RWr0), turn on and off Error clear request flag (RYA).

- When a moderate error occurs

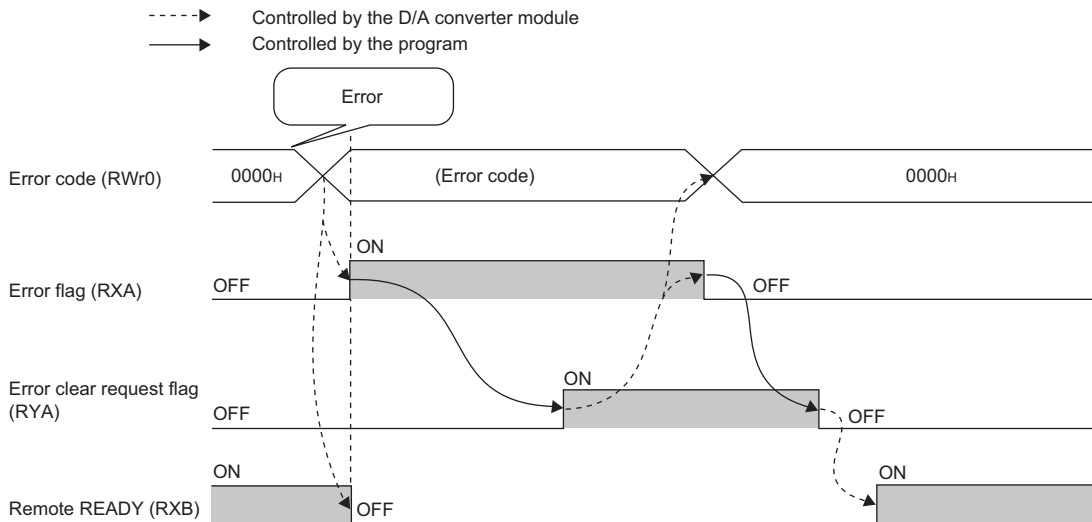

- When a major error occurs

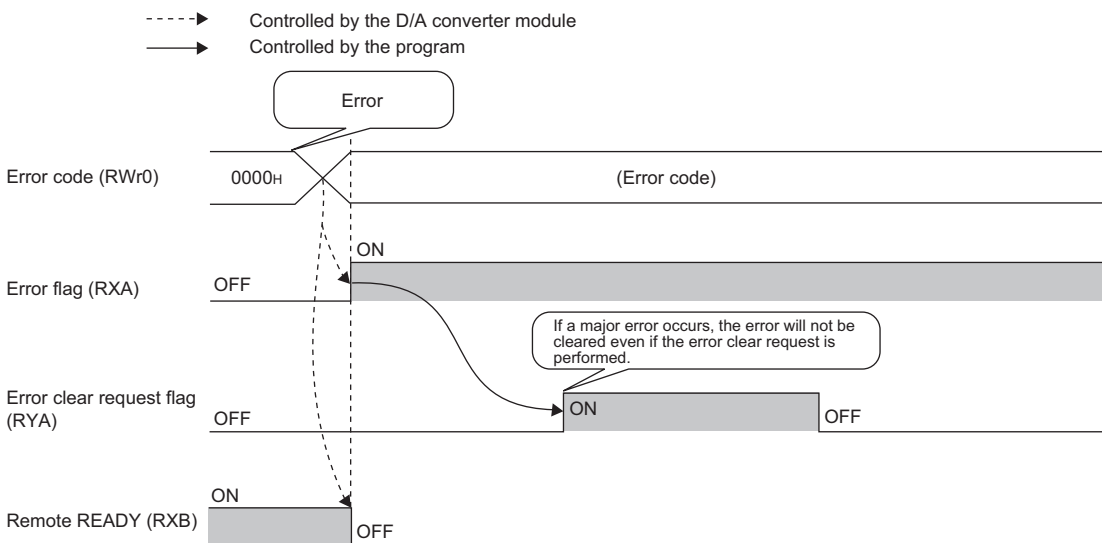

(a) Error history

The error history is not cleared even if Error clear request flag (RYA) is turned on and off. To clear the error history, set "1" in Error history clear command (address: 1000_H).

For the error history clear, refer to the following.

- Error history clear command (address: 1000_H) (☞ Page 148, Appendix 3 (14))

A

Appendix 1 Details of Remote I/O Signals
 Appendix 1.1 Remote Input signals

(4) Remote READY (RXB)

This signal is used as an interlock condition when the master station reads/writes data to/from the remote register or remote buffer memory areas of the D/A converter module.

The signal turns on when the module power supply is turned on.

When Error flag (RXA) turns on, the signal turns off.

(5) Alert output signal (RX1E)

If the digital value in any D/A conversion enabled channels becomes any of the following status, this signal is turned on.

- Digital value > Alert output upper limit value
- Digital value < Alert output lower limit value

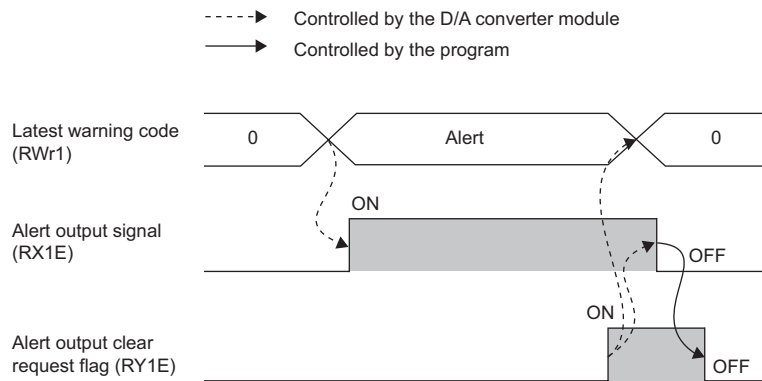

(a) How to turn off the signal

Turn off the signal by either of the following methods.

- Turning on and off Alert output clear request flag (RY1E)
- Turning on and off Initial data setting request flag (RY9)

When an alarm code is stored in Latest warning code (RW1), this signal is cleared.

(6) External power supply monitor state flag (RX1F)

This signal turns on when the external power supply monitoring function is being activated by External power supply monitor request flag (RY1F).

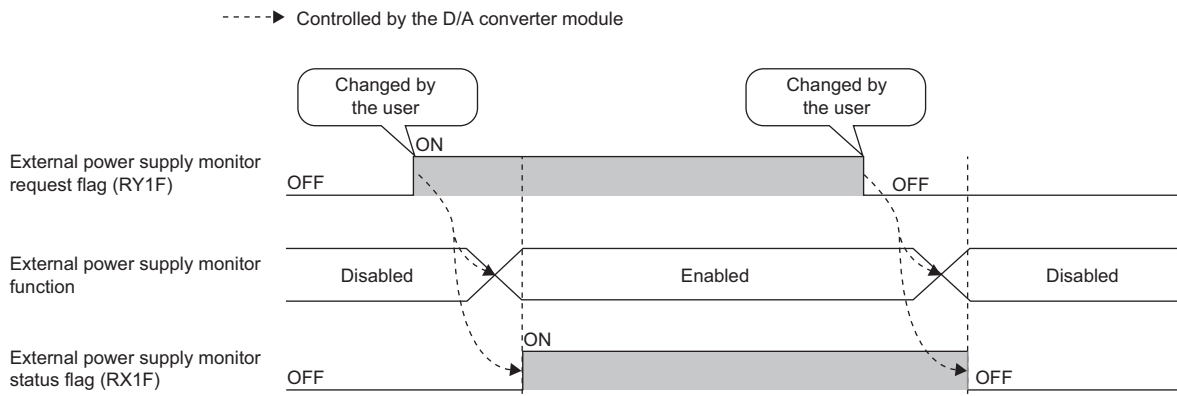

For the external power supply monitoring function, refer to the following.

- External power supply monitoring function (☞ Page 98, Section 8.11 (2))

Appendix 1.2 Remote output signals

(1) Initial data setting request flag (RY9)

Turn on this signal after writing parameter data to the remote buffer memory.

Initial data setting completed flag (RX9) turns on when the operating condition is changed.

For the on and off timing, refer to the following.

- Initial data setting completed flag (RX9) (☞ Page 132, Appendix 1.1 (2))

(2) Error clear request flag (RYA)

This signal is used to clear Error flag (RXA) and Latest error code (RW0).

(a) When a moderate error occurs

When this signal is turned on after the cause of the error is eliminated, the error status is cleared and Error flag (RXA) turns off.

If the signal is turned off before Error flag (RXA) turns off, Error flag (RXA) cannot be turned off.

For the on and off timing, refer to the following.

- Error flag (RXA) (☞ Page 133, Appendix 1.1 (3))

(b) When a major error occurs

Error flag (RXA) cannot be turned off even if this signal is turned on and off.

For the on and off timing, refer to the following.

- Error flag (RXA) (☞ Page 133, Appendix 1.1 (3))

(3) CH□ Output enable/disable flag (RY10 to RY13)

Set whether to output the D/A conversion value or the offset value for each channel.

ON: D/A conversion value

OFF: Offset value

(a) D/A conversion speed

Regardless of turning on this signal, $100\mu\text{s} \times$ the number of conversion enabled channels is applied.

(4) Alert output clear request flag (RY1E)

Turn on and off this signal to clear an alert output.

For the on and off timing, refer to the following.

- Alert output signal (RX1E) (☞ Page 134, Appendix 1.1 (5))

(5) External power supply monitor request flag (RY1F)

Turn on this flag to activate the external power supply monitoring function.

For the on and off timing, refer to the following.

- External power supply monitor state flag (RX1F) (☞ Page 134, Appendix 1.1 (6))

Appendix 2 Details of Remote Register Areas

This section describes the details of remote register areas for communications with the master/local module. The assignment of each device number is for the case when the remote registers of the main module are assigned to RWr0 to RWrF and RWw0 to RWwF.

(1) Latest error code (RWr0)

An error code is stored when a moderate error or major error occurs.

To clear the error code, turn on Error clear request flag (RYA) after eliminating the cause of the error.

Errors that occurred in the past can be checked with Error history area (address: 0A00_H to 0FFF_H). For the error history, refer to the following.

- Error history area (address: 0A00_H to 0FFF_H) (☞ Page 38, Section 3.7 (3))

(2) Latest warning code (RWr1)

An error code is stored when a minor error occurs. An alarm code is stored when an alarm occurs.

Five seconds after the cause of the error is eliminated, the error code or alarm code is automatically cleared.

Errors or alarms that occurred in the past can be checked with Error history area (address: 0A00_H to 0FFF_H). For the error history, refer to the following.

- Error history area (address: 0A00_H to 0FFF_H) (☞ Page 38, Section 3.7 (3))

(3) CH□ Set value check code (RWr2 to RWr5)

When the set digital value is out of the setting range, the check code is stored.

For details on the digital value range check function, refer to the following.

- Digital Value Range Check Function (☞ Page 89, Section 8.8)

The following table lists the check codes.

Check code	Description
000F _H	A digital value exceeding the setting range is written.
00F0 _H	A digital value less than the setting range is written.
00FF _H	Digital values greater and less than the setting range are written. For example, the check code 00FF _H is stored when a digital value less than the setting range is written after a digital value greater than the setting range is written and the check code is not reset.

The stored check code is not cleared even if the digital value falls within the setting range.

When Scaling enable/disable setting (address: 010E_H) is set to Enable (0), the scale-converted digital value is the target for the check code. However, when the scale-converted digital value is out of the setting range, a slight inaccuracy may be contained in the target digital value for the check code when the check code is stored due to an operational error in the scale conversion.

When a value is set for CH□ Shifting set value (RWw6 to RWw9), the value with the shifting set value added is the target for the check code.

(a) Resetting set value check codes

The check codes can be reset in the following two procedures:

- Write a digital value within the setting range, and turn on and off Error clear request flag (RYA).
- Turn on and off Initial data setting request flag (RY9).

(b) Default value

Within the setting range (0000_H) is stored.

(4) Alert output flag (RWrA)

Alert status (upper limit value or lower limit value) for each channel can be checked.

For details on the alert output function, refer to the following.

- Alert Output Function (Page 92, Section 8.9)

b15	b14	b13	b12	b11	b10	b9	b8	b7	b6	b5	b4	b3	b2	b1	b0
0	0	0	0	0	0	0	0	CH4 Lower limit value	CH4 Upper limit value	CH3 Lower limit value	CH3 Upper limit value	CH2 Lower limit value	CH2 Upper limit value	CH1 Lower limit value	CH1 Upper limit value

Data for b8 to b15 are fixed to "0".

0: Normal
1: Alert

(a) Alert output flag (RWrA) status

On any of the following conditions, Alert (1) is stored to Alert output flag corresponding to each channel.

- Digital value > Alert output upper limit value
- Digital value < Alert output lower limit value

When an alert is detected in any D/A conversion enabled or alert output enabled channels, Alert output signal (RX1E) is also turned on.

(b) Clearing Alert output flag (RWrA)

Alert output flag (RWrA) is cleared by either of the following two methods.

- Turning on and off Alert output clear request flag (RY1E)
- Turning on and off Initial data setting request flag (RY9)

(c) Default value

The default value is set to Normal (0) for all channels.

(5) CH□ Digital value (RWw2 to RWw5)

On this area, the digital value for D/A conversion is written, in signed 16-bit binary, from the CPU module.

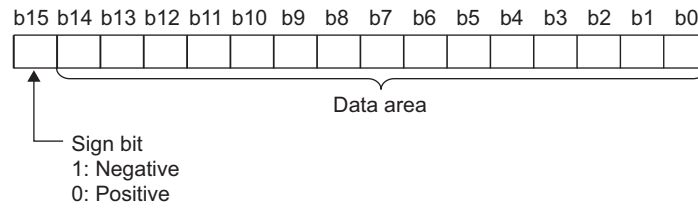

Output range setting	When the scaling function is disabled		When the scaling function is enabled*1
	Setting range (Actual range)	Digital value when a value out of the setting range is written	Setting range
0: 4 to 20mA	-288 to 12287 (Actual range: 0 to 12000)	12288 or more: 12287 -289 or less: -288	-32768 to 32767 (Maximum actual range: -32000 to 32000)
1: 0 to 20mA			
2: 1 to 5V			
3: 0 to 5V			
4: -10 to 10V	-16384 to 16383 (Actual range: -16000 to 16000)	16384 or more: 16383 -16385 or less: -16384	
5: User range setting 1 (-10 to 10V)	-12288 to 12287 (Actual range: -12000 to 12000)	12288 or more: 12287 -12289 or less: -12288	
6: User range setting 2 (0 to 20mA)	-288 to 12287 (Actual range: 0 to 12000)	12288 or more: 12287 -289 or less: -288	

*1 The setting range and the actual range of when the scaling function is enabled depend on the settings in the scaling upper limit value and the scaling lower limit value.

(a) When a value out of the setting range is written

D/A conversion is performed with the upper and lower limit value of the setting range. Simultaneously, the following status notifies that the setting is out of the range.

- The check code is stored in CH□ Set value check code (RWw2 to RWw5).
For details on check codes, refer to the following.

Page 136, Appendix 2 (3)

- The error code (060□) for an out-of-range digital value is stored in Latest warning code (RWw1).
- Warning flag (RX7) turns on.
- The ALM LED flashes.

(b) Default value

The default value is set to 0 for all channels.

(6) CH□ Shifting set value (RWw6 to RWw9)

Set the shifting set value that is to be used for the shift function in signed 16-bit binary. The digital value with shift addition is D/A converted.

For details on the shift function, refer to the following.

- Shift Function (☞ Page 85, Section 8.7)

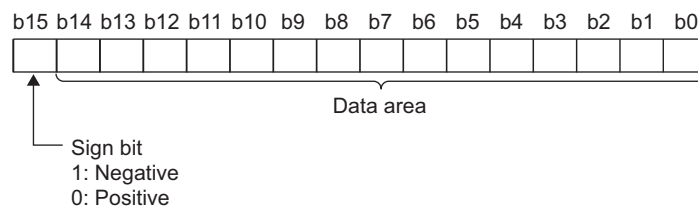
**(a) Setting range**

-32768 to 32767

(b) Enabling the setting

When the value is set, shifting set value turns valid regardless of turning on and off Initial data setting request flag (RY9).

(c) Default value

The default value is set to 0 for all channels.

Appendix 3 Details of Remote Buffer Memory Areas

This section describes the details of remote buffer memory areas of the D/A converter module.

(1) Alert output signal assignment (address: 0004_H)

Assign Alert output signal (RX1E) to Remote output (RY) of the extension output module using the external signal assignment function. When an alert occurs, assigned Remote output (RY) turns on.

(a) Setting range

The remote output (RY) number of the extension module, which is counted from the start remote output (RY) number (0000_H) of the main module, is set.

Ex. The following is an example for assigning Alert output signal (RX1E) to the remote output (RY) number, 2_H, of the extension output module.

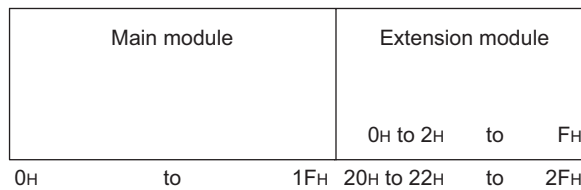

The remote output (RY) number, 2_H, is 22_H when counted from the start remote output (RY) number of the main module.

Thus, set 22_H for Alert output signal assignment (address: 0004_H).

(b) Enabling the setting

Turn on and off Initial data setting request flag (RY9).

(c) Default value

The default value is set to No assignment (FFFF_H).

Point

If a value out of the setting range is set, an error occurs. The error code (0172_H) is stored in Latest error code (RWr0), Error flag (RXA) turns on, and the ERR. LED turns on. The operation is performed in the previous setting.

(2) Error flag assignment (address: 0005_H)

Error flag (RXA) is assigned to the remote output (RY) of the extension output module using the external signal assignment function. When a moderate or major error occurs, the assigned remote output (RY) turns on.

(a) Setting range

The remote output (RY) number of the extension output module, counted from the start remote output (RY) number (0000_H) of the main module, is set.

Ex. The following is an example for assigning Error flag (RXA) to the remote output (RY) number, 4_H, of the extension output module.

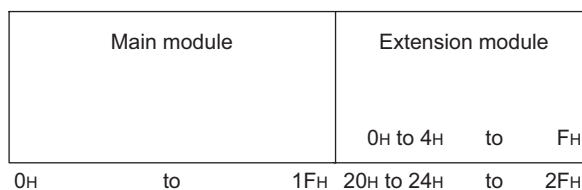

The remote output (RY) number, 4_H, is 24_H when counted from the start remote output (RY) number of the main module.

Thus, set 24_H for Alert output signal assignment (address: 0004_H).

(b) Enabling the setting

Turn on and off Initial data setting request flag (RY9).

(c) Default value

The default value is set to No assignment (FFFF_H).

Point

If a value out of the setting range is set, an error occurs. The error code (0173_H) is stored in Latest error code (RWr0), Error flag (RXA) turns on, and the ERR. LED turns on. The operation is performed in the previous setting.

(3) Warning flag assignment (address: 0006_H)

Warning flag (RX7) is assigned to the remote output (RY) of the extension output module using the external signal assignment function. When a minor error occurs, the assigned remote output (RY) turns on.

(a) Setting range

The remote output (RY) number of the extension output module, counted from the start remote output (RY) number (0000_H) of the main module, is set.

Ex. The following is an example for assigning Warning flag (RX7) to the remote output (RY) number, 6_H, of the extension output module.

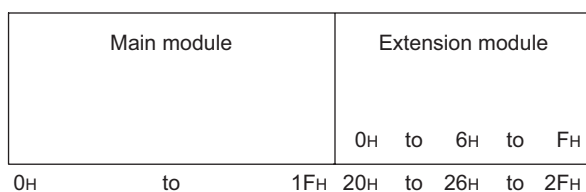

The remote output (RY) number, 6_H, is 26_H when counted from the start remote output (RY) number of the main module.

Thus, set 26_H for Warning flag assignment (address: 0006_H).

(b) Enabling the setting

Turn on and off Initial data setting request flag (RY9).

(c) Default value

The default value is set to No assignment (FFFF_H).

Point

If a value out of the setting range is set, an error occurs. The error code (0174_H) is stored in Latest error code (RW_r0), Error flag (RXA) turns on, and the ERR. LED turns on. The operation is performed in the previous setting.

(4) Cyclic data update watch time setting (address: 0007_H)

This signal is used to set the time to monitor the data update interval of the cyclic transmission (watch time). When the cyclic transmission remains stopped longer than the cyclic data update watch time, the D/A converter module is regarded as disconnected from data link and the output status is held or cleared by Digital output HOLD/CLEAR setting (address: 0011_H) and Analog output HOLD/CLEAR setting (address: 0104_H).

For Digital output HOLD/CLEAR setting (address: 0011_H), refer to the following.

- Digital output HOLD/CLEAR setting (address: 0011_H) (☞ Page 144, Appendix 3 (6))

For Analog output HOLD/CLEAR setting (address: 0104_H), refer to the following.

- Analog output HOLD/CLEAR setting (address: 0104_H) (☞ Page 145, Appendix 3 (9))

(a) Setting range

Setting range is 0 (Not monitor) or 1 to 20 (0.1 to 2 seconds). Set the value in increments of 1 (100ms).

(b) Enabling the setting

Turn on and off Initial data setting request flag (RY9).

(c) Default value

The default value is set to Not monitor (0).

Point

If a value out of the setting range is set, the error code (0930_H) is stored in Latest error code (RWr0), Error flag (RXA) turns on, and the ERR. LED turns on. Then the I/O operation stops.

(5) Input response time setting (address: 0010_H)

The input response time of the extension input module is set.

Input response time	Setting value
1.0ms	2 _H
1.5ms	3 _H
5ms	4 _H
10ms	5 _H
20ms	6 _H
70ms	7 _H

(a) Enabling the setting

Turn on and off Initial data setting request flag (RY9).

(b) Default value

The default value is set to 10ms (5_H).

Point

- If data other than the above is set, an error occurs. The error code (1F40_H) is stored in Latest error code (RWr0), Error flag (RXA) turns on, and the ERR. LED turns on.
- If no extension input module is connected, the setting in this area is ignored.

(6) Digital output HOLD/CLEAR setting (address: 0011_H)

The output HOLD/CLEAR status of the extension output module is set.

For the output HOLD/CLEAR setting function, refer to the following.

 CC-Link IE Field Network Remote I/O Module User's Manual

Digital output HOLD/CLEAR setting	Setting value
CLEAR	0 _H
HOLD	1 _H

(a) Enabling the setting

Turn on and off Initial data setting request flag (RY9).

(b) Default value

The default value is CLEAR (0_H).

Point

- If no extension output module is connected, the setting in this area is ignored.
- When the data other than above is set, the D/A converter module operates with the setting value of the lower 1 bit.

(7) D/A conversion enable/disable setting (address: 0102_H)

The D/A conversion enable/disable status is set for each channel.

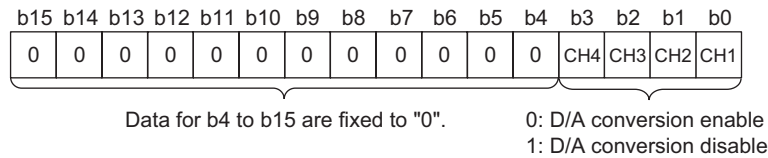

(a) Enabling the setting

Turn on and off Initial data setting request flag (RY9).

(b) Default value

The default value is set to D/A conversion disable (1) for all channels.

(8) Range setting (address: 0103_H)

The output range is set for each channel.

b15 to b12	b11 to b8	b7 to b4	b3 to b0
CH4	CH3	CH2	CH1

Output range	Setting value
4 to 20mA	0 _H
0 to 20mA	1 _H
1 to 5V	2 _H
0 to 5V	3 _H
-10 to 10V	4 _H
User range setting 1 (-10 to 10V)	5 _H
User range setting 2 (0 to 20mA)	6 _H

(a) Enabling the setting

Turn on and off Initial data setting request flag (RY9).

(b) Default value

The default value is set to 4 to 20mA (0_H).

Point

If data other than the above is set, an error occurs. The error code (010□_H) is stored in Latest error code (RW_r0), Error flag (RXA) turns on, and the ERR. LED turns on.

(9) Analog output HOLD/CLEAR setting (address: 0104_H)

Whether to hold or clear the analog value that is output at the state of CPU module being RUN, STOP, or when an error occurs, is set for each channel.

b15 to b12	b11 to b8	b7 to b4	b3 to b0
CH4	CH3	CH2	CH1

Analog output HOLD/CLEAR setting	Setting value
CLEAR	0 _H
HOLD	1 _H to F _H (a number other than 0)

(a) Enabling the setting

Turn on and off Initial data setting request flag (RY9).

(b) Default value

The default value is CLEAR (0_H).

(10) Alert output setting (address: 0105_H)

The alert output enable/disable status is set for each channel.

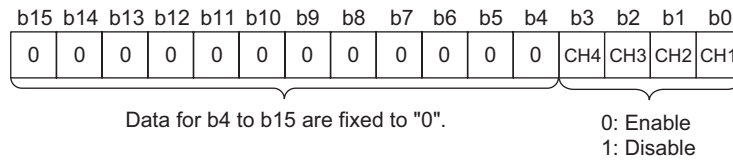

(a) Enabling the setting

Turn on and off Initial data setting request flag (RY9).

(b) Default value

The default value is set to Disable (1) for all channels.

(11) CH□ Alert output upper limit value (address: 0106_H, 0108_H, 010A_H, 010C_H),

CH□ Alert output lower limit value (address: 0107_H, 0109_H, 010B_H, 010D_H)

The upper and lower limit values of the alert output range are set.

For details on the alert output function, refer to the following.

- Alert Output Function (📄 Page 92, Section 8.9)

(a) Setting range

- Setting range: -32768 to 32767
- The value to be set must satisfy the condition of Alert output upper limit value > Alert output lower limit value. An error occurs in a channel for which the setting not satisfying the condition is set. The error code (062□_H) is stored in Latest error code (RW_r0), Error flag (RXA) turns on, and the ERR. LED turns on.
- If the scaling function or shift functions is used, an alert target is the digital value where the operation of each function is reflected. Set the digital value considering the operation result of the function.
- If Disable (1) is set to Alert output setting (address: 0105_H), the settings of CH□ Alert output upper limit value (address: 0106_H, 0108_H, 010A_H, 010C_H) and CH□ Alert output lower limit value (address: 0107_H, 0109_H, 010B_H, 010D_H) are ignored.

(b) Enabling the setting

Turn on and off Initial data setting request flag (RY9).

(c) Default value

The default value is set to 0 for all channels.

Point

Because the default value is set to 0, change the setting value when using the alert output function.

(12)Scaling enable/disable setting (address: 010E_H)

The scaling enable/disable status is set for each channel.

For details on the scaling function, refer to the following.

Scaling Function (☞ Page 79, Section 8.6)

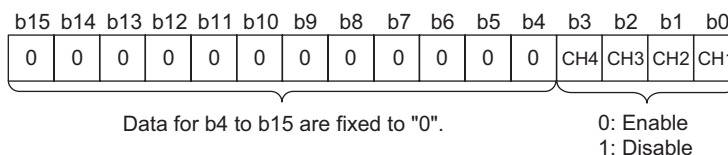
**(a) Enabling the setting**

Turn on and off Initial data setting request flag (RY9).

(b) Default value

The default value is set to Disable (1) for all channels.

(13)CH□ Scaling lower limit value (address: 010F_H, 0111_H, 0113_H, 0115_H),**CH□ Scaling upper limit value (address: 0110_H, 0112_H, 0114_H, 0116_H)**

The scale conversion range is set for each channel.

For details on the scaling function, refer to the following.

- Scaling Function (☞ Page 79, Section 8.6)

(a) Setting range

- Setting range: -32000 to 32000
- An error occurs in a channel for which a value out of the setting range above is set. The error code (090□_H) is stored in Latest error code (RW_r0), Error flag (RXA) turns on, and the ERR. LED turns on.
- The value to be set must satisfy the condition of Scaling upper limit value > Scaling lower limit value. An error occurs in a channel for which the setting not satisfying the condition is set. The error code (091□_H) is stored in Latest error code (RW_r0), Error flag (RXA) turns on, and the ERR. LED turns on.
- If Scaling enable/disable setting (address: 010E_H) is set to Disable (1), the settings of CH□ Scaling lower limit value (address: 010F_H, 0111_H, 0113_H, 0115_H) and CH□ Scaling upper limit value (address: 0110_H, 0112_H, 0114_H, 0116_H) are ignored.

(b) Enabling the setting

Turn on and off Initial data setting request flag (RY9).

(c) Default value

The default value is set to 0 for all channels.



Because the default value is set to 0, change the setting value when using the scaling function.

(14)Error history □ (address: 0A00_H to 0AEF_H)

Up to 15 errors occurred in the module are stored.

The following shows the contents stored in Error history 1 (address: 0A00_H to 0A0F_H).

	b15	to	b8	b7	to	b0
0A00 _H	Error code					
0A01 _H	Order of generation					
0A02 _H	First two digits of the year			Last two digits of the year		
0A03 _H	Month			Date		
0A04 _H	Hour			Minute		
0A05 _H	Second			00 _H (Fixed)		
0A06 _H	CH1 Digital value					
0A07 _H	CH2 Digital value					
0A08 _H	CH3 Digital value					
0A09 _H	CH4 Digital value					
0A0A _H to 0A0F _H	System area					

Item	Contents	Storage example ^{*1}
Error code	The error code of the error that occurred is stored.	-
Order of generation	The order of error occurrence is stored.	2 _H
First two digits of the year/Last two digits of the year ^{*2}	The items on the left are stored in BCD code.	2012 _H
Month/Date ^{*2}		0901 _H
Hour/Minute ^{*2}		1330 _H
Second/00 _H (Fixed) ^{*2}		5000 _H
CH1 Digital value	The value of CH□ Digital value (RWw2 to RWw5) when an error occurs is stored.	-
CH2 Digital value		
CH3 Digital value		
CH4 Digital value		

*1 Those are values when the second error occurs at 13:30:50, September 1st, 2012.

*2 The clock information of the error that occurred is based on the clock information acquired from the CPU module of the master station.

When an error has occurred before the clock information is acquired from the CPU module, the error time is not recorded.

Error history 2 to Error history 15 (address: 0A10_H to 0AEF_H) are stored in the same format as that of Error history 1 (address: 0A00_H to 0A0F_H).

For the error codes, refer to the following.

- Error Code List (Page 119, Section 11.2)

(a) Storage order

The latest error is stored in Error history 1 (address: 0A00_H to 0A0F_H).

Errors that occurred in the past are stored in Error history 2 to Error history 15 (address: 0A10_H to 0AEF_H) in reverse chronological order.

If 16 or more errors occur, errors are deleted from the oldest.

(15)Error history clear command (address: 1000_H)

This command is used to clear the error history stored in the nonvolatile memory.

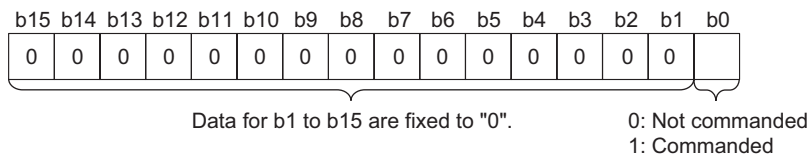

(a) Clearing the error history

The error history is cleared when Commanded (1) is set to this area.

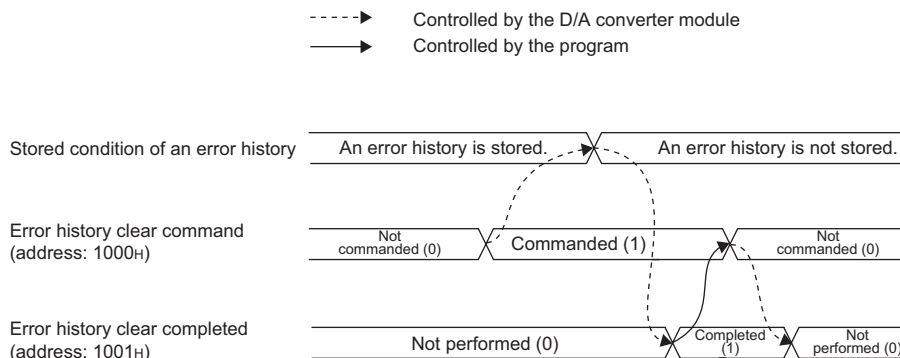

(b) Default value

The default value is set to Not commanded (0).

(16)Error history clear completed (address: 1001_H)

This remote buffer memory shows the error history clear completed status stored in the nonvolatile memory.

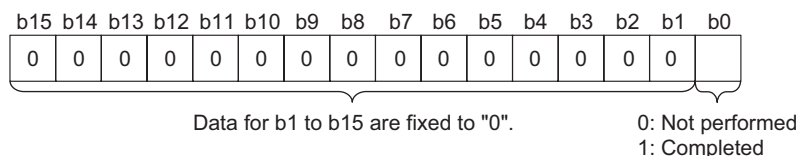

(a) Clearing the error history

When the error history is cleared, the value in this area changes to Completed (1).

For the on and off timing, refer to the following.

- Error history clear command (address: 1000_H) (Page 149, Appendix 3 (15))

(b) Default value

The default value is set to Not performed (0).

(17)Parameter area initialization command (address: 1002_H)

This command is used to clear the parameter stored in the nonvolatile memory.

The module can be restored using this command when Nonvolatile memory data error (parameter) (error code: 0130_H) occurs.

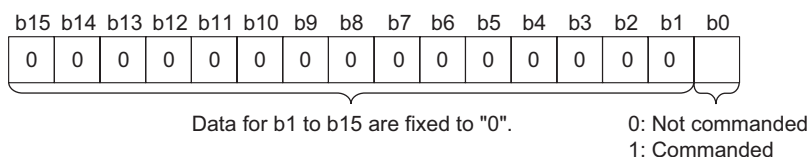

A

Appendix 3 Details of Remote Buffer Memory Areas

(a) Initializing the parameter area

The parameters stored in a nonvolatile memory are set back to their default values when Commanded (1) is set in this area.

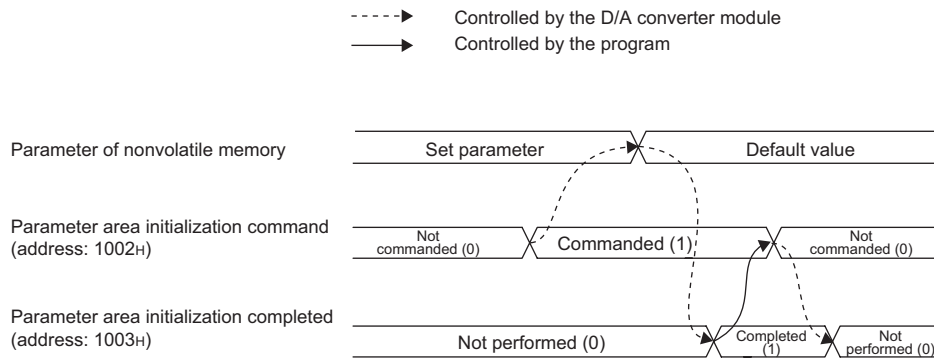

(b) Default value

The default value is set to Not commanded (0).

Point

Even if Parameter area initialization command (address: 1002_H) is executed, the following remote input signals are not cleared.

- Warning flag (RX7)
- Error flag (RXA)
- Alert output signal (RX1E)

In addition, Remote READY (RXB) does not turn on.

After Parameter area initialization command (address: 1002_H) is performed, the D/A converter module operates normally by turning off and on the module.

(18)Parameter area initialization completed (address: 1003_H)

This remote buffer memory shows the clear completed status of the parameter stored in the nonvolatile memory.

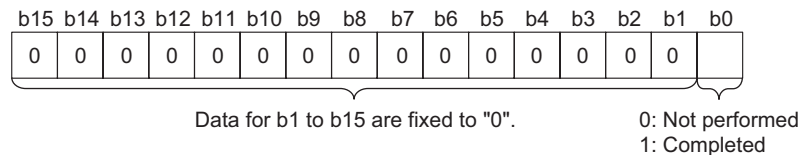

(a) Initializing the parameter area

When the parameters stored in a nonvolatile memory are set back to their default values, the value in this area changes to Completed (1). For the on and off timing, refer to the following.

- Parameter area initialization command (address: 1002_H) (Page 149, Appendix 3 (17))

(b) Default value

The default value is set to Not performed (0).

(19)Module operation information initialization command (address: 1004_H)

This command is used to clear the module operation information stored in the nonvolatile memory. The module operation information can be initialized only when Nonvolatile memory data error (module operation information) (error code: 0110_H) has occurred.

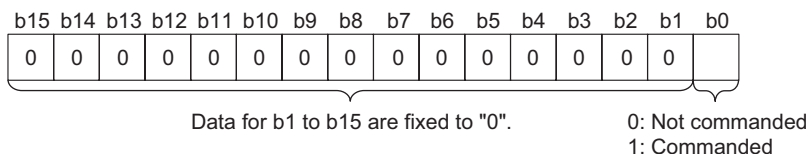

(a) Initializing the module operation information

The module operation information is initialized when the value in this area is set to Commanded (1).

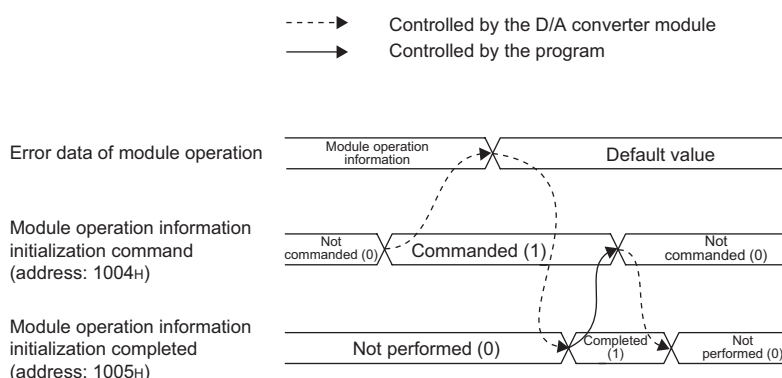

(b) Default value

The default value is set to Not commanded (0).

(20)Module operation information initialization completed (address: 1005_H)

The initialization status of the module operation information stored in a nonvolatile memory is stored.

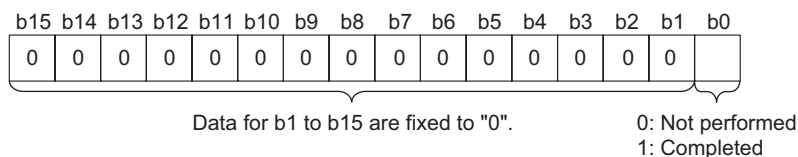

(a) Initializing the module operation information

When initialization of the module operation information is completed, the value in this area changes to Completed (1). For the on and off timing, refer to the following.

- Module operation information initialization command (address: 1004_H) (Page 151, Appendix 3 (19))

(b) Default value

The default value is set to Not performed (0).

A

Appendix 3 Details of Remote Buffer Memory Areas

Appendix 4 I/O Conversion Characteristic of D/A Conversion

The I/O conversion characteristics of D/A conversion are the gradient of a straight line connecting an offset value and a gain value when a digital value written from the CPU module is converted to an analog output value (voltage or current output).

(1) Offset value

An analog output value (voltage or current) corresponding to the digital value 0 under the condition that the scaling function and the shift function are not used.

(2) Gain value

An analog output value (voltage or current) corresponding to the following digital value under the condition that the scaling function and the shift function are not used.

- 12000 (When the output range is set to 0 to 5V, 1 to 5V, 0 to 20mA, 4 to 20mA, user range setting 1, or user range setting 2)
- 16000 (When the output range is set to -10 to 10V)

(3) Voltage output characteristics

The following graph shows the voltage output characteristics.

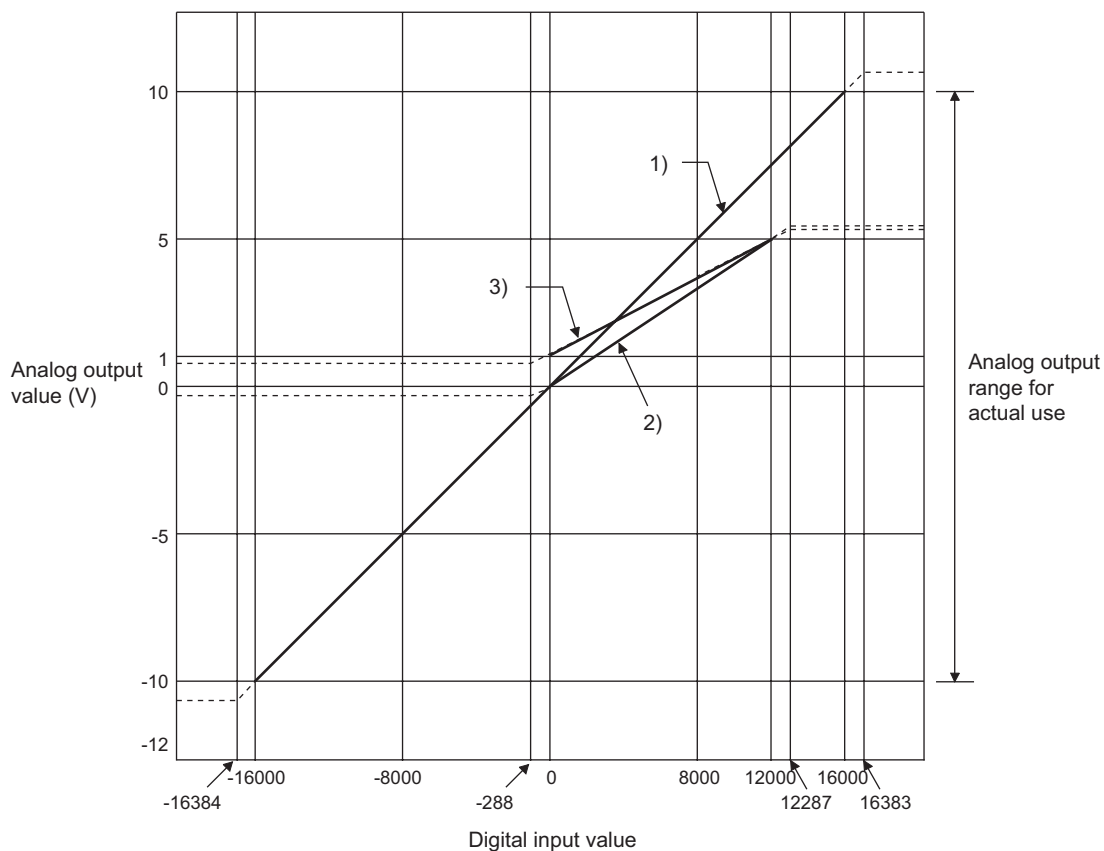

No.	Output range setting	Offset value	Gain value	Digital value	Maximum resolution
1)	-10 to 10V	0V	10V	-16000 to 16000	0.625mV
2)	0 to 5V	0V	5V	0 to 12000	0.416mV
3)	1 to 5V	1V	5V		0.333mV
-	User range setting 1 (-10 to 10V)	*1	*1	-12000 to 12000	0.333mV

- *1 Set the offset value and gain value in the user range setting within the range satisfying the following two conditions.
- Setting range: -10 to 10V
 - ((Gain value) - (Offset value)) ≥ 4.0V



Use the value within the practical digital input range and practical analog output range. If a value is out of the range, the maximum resolution and accuracy may not fall within the range of performance specifications. (Do not use the value in the dotted line region in the above graph.)

A

Appendix 4 I/O Conversion Characteristic of D/A Conversion

(4) Current output characteristics

The following graph shows the current output characteristics.

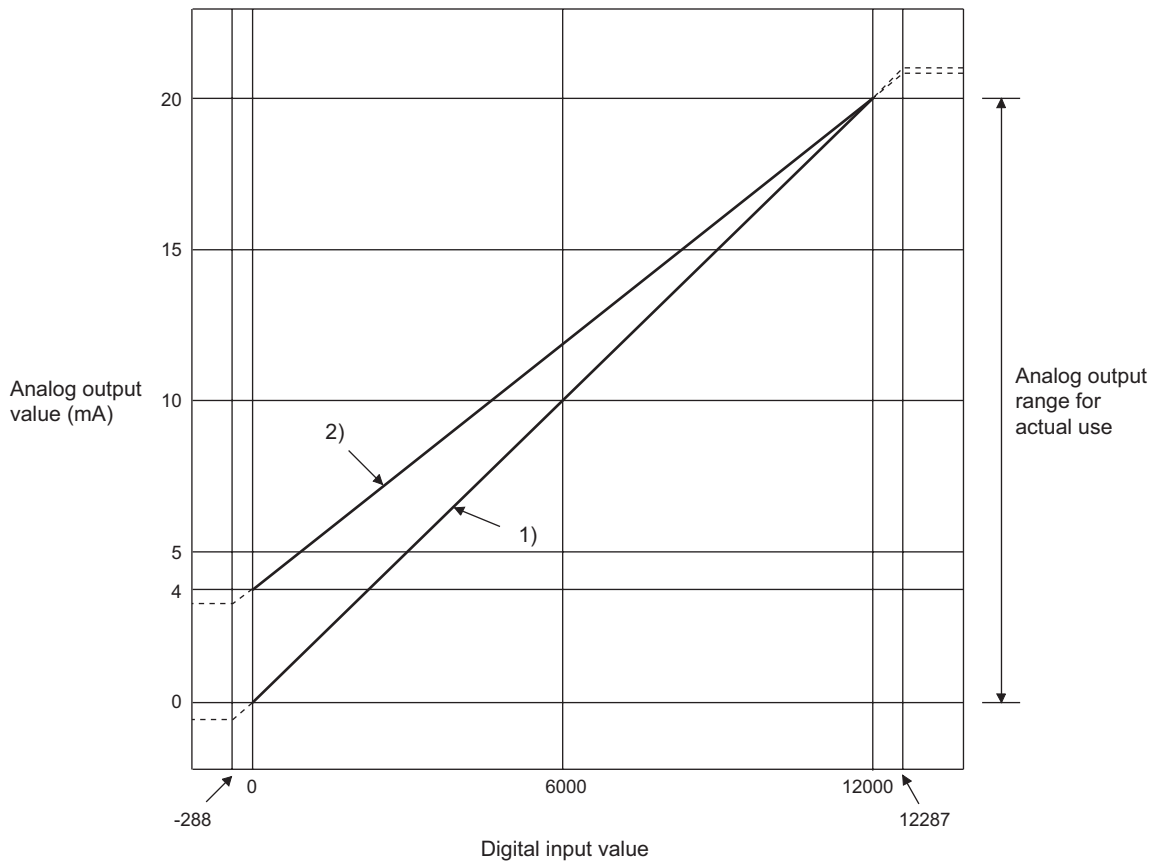

No.	Output range setting	Offset value	Gain value	Digital value	Maximum resolution
1)	4 to 20mA	4mA	20mA	0 to 12000	1.66 μ A
2)	0 to 20mA	0mA	20mA		1.33 μ A
-	User range setting 2 (0 to 20mA)	*1	*1		0.95 μ A

- *1 Set the offset value and gain value in the user range setting within the range satisfying the following two conditions.
- Setting range: 0 to 20mA
 - ((Gain value) - (Offset value)) \geq 11.4mA

Point

Use the value within the practical digital input range and practical analog output range. If a value is out of the range, the maximum resolution and accuracy may not fall within the range of performance specifications. (Do not use the value in the dotted line region in the above graph.)

Appendix 5 Accuracy of D/A Conversion

The accuracy is measured for the maximum analog output value.

Even if the offset/gain setting or output range is changed to change output characteristics, the accuracy remains the same, and is kept within the range described in performance specifications.

The following graph shows the variation range of the accuracy for the 0 to 5V range.

When the operating ambient temperature is $25\pm 5^{\circ}\text{C}$, an analog value is output with the accuracy within $\pm 0.2\%$ ($\pm 10\text{mV}$) and when the operating ambient temperature is 0 to 55°C , $\pm 0.3\%$ ($\pm 15\text{mV}$). (Note that this will not apply when the D/A converter module is influenced by noise.)

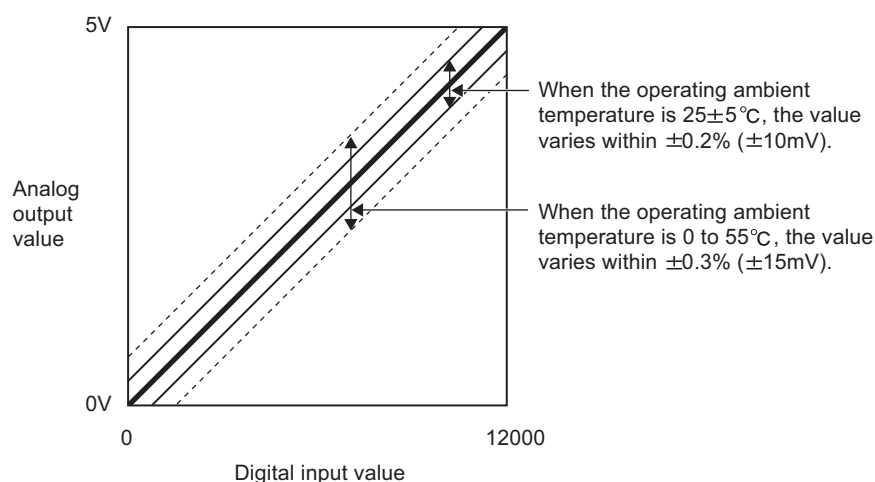

Appendix 6 Conversion Speed of D/A Conversion

The conversion speed is the time for D/A-converting CH□ Digital value (RWw2 to RWw5) and outputting the converted analog output value actually.

However, the CC-Link IE Field Network system requires additional time for data link processing. Therefore, the time of the cycle to output the analog output value actually is calculated by the following formula.

Data link processing time = SM + LS + Remote device station processing time [ms]

SM	: Scan time of the program in the master station
LS	: Link scan time
Remote device station processing time	: Conversion speed × Number of D/A conversion-enabled channels

For details on the data link processing time, refer to the following.

User's manual for the master/local module used

Appendix 7 EMC and Low Voltage Directives

Compliance to the EMC Directive, which is one of the EU Directives, has been a legal obligation for the products sold in European countries since 1996 as well as the Low Voltage Directive since 1997.

Manufacturers who recognize their products are compliant to the EMC and Low Voltage Directives are required to attach a "CE mark" on their products.

(1) Sales representative in EU member states

Authorized representative in EU member states is shown below.

Name: Mitsubishi Electric Europe BV

Address: Gothaer Strasse 8, 40880 Ratingen, Germany

Appendix 7.1 Measures to comply with the EMC Directive

The EMC Directive specifies that "products placed on the market must be so constructed that they do not cause excessive electromagnetic interference (emissions) and are not unduly affected by electromagnetic interference (immunity)".

This section summarizes the precautions on compliance with the EMC Directive of the machinery constructed with the module.

These precautions are based on the requirements and the standards of the regulation, however, it does not guarantee that the entire machinery constructed according to the descriptions will comply with abovementioned directives.

The method and judgement for complying with the EMC Directive must be determined by the person who constructs the entire machinery.

(1) EMC Directive related standards

(a) Emission requirements

Specification	Test item	Test details	Standard value
EN61131-2: 2007	CISPR16-2-3 Radiated emission* ²	Radio waves from the product are measured.	<ul style="list-style-type: none"> • 30M-230MHz QP: 40dBμV/m (10m in measurement range)*¹ • 230M-1000MHz QP: 47dBμV/m (10m in measurement range)
	CISPR16-2-1, CISPR16-1-2 Conducted emission* ²	Noise from the product to the power line is measured.	<ul style="list-style-type: none"> • 150k-500kHz QP: 79dB, Mean: 66dB*¹ • 500k-30MHz QP: 73dB, Mean: 60dB

*1 QP: Quasi-peak value, Mean: Average value

*2 The module is an open type device (a device designed to be housed in other equipment) and must be installed inside a conductive control panel. The tests were conducted with the module installed in a control panel.

(b) Immunity requirements

Specification	Test item	Test details	Standard value
EN61131-2: 2007	EN61000-4-2 Electrostatic discharge immunity ^{*1}	Immunity test in which electrostatic is applied to the cabinet of the equipment.	<ul style="list-style-type: none"> • 8kV Air discharge • 4kV Contact discharge
	EN61000-4-3 Radiated, radio-frequency, electromagnetic field immunity ^{*1}	Immunity test in which electric fields are irradiated to the product.	80% AM modulation@1kHz <ul style="list-style-type: none"> • 80M-1000MHz: 10V/m • 1.4G-2.0GHz: 3V/m • 2.0G-2.7GHz: 1V/m
	EN61000-4-4 Electrical fast transient/burst immunity ^{*1}	Immunity test in which burst noise is applied to the power line and signal line.	<ul style="list-style-type: none"> • AC/DC main power, I/O power, AC I/O (unshielded): 2kV • DC I/O, analog, communication: 1kV
	EN61000-4-5 Surge immunity ^{*1}	Immunity test in which lightning surge is applied to the power line and signal line.	<ul style="list-style-type: none"> • AC power line, AC I/O power, AC I/O (unshielded): 2kV CM, 1kV DM • DC power line, DC I/O power: 0.5kV CM, DM • DC I/O, AC I/O (shielded), analog^{*2}, communication: 1kV CM
	EN61000-4-6 Immunity to conducted disturbances, induced by radio-frequency fields ^{*1}	Immunity test in which high frequency noise is applied to the power line and signal line	0.15M-80MHz, 80% AM modulation @1kHz, 10Vrms
	EN61000-4-8 Power-frequency magnetic field immunity ^{*1}	Immunity test in which the product is installed in inductive magnetic field	50Hz/60Hz, 30A/m
	EN61000-4-11 Voltage dips and interruption immunity ^{*1}	Immunity test in which power supply voltage is momentarily interrupted	<ul style="list-style-type: none"> • Apply at 0%, 0.5 cycles and zero-cross point • 0%, 250/300 cycles (50/60Hz) • 40%, 10/12 cycles (50/60Hz) • 70%, 25/30 cycles (50/60Hz)

*1 The module is an open type device (a device designed to be housed in other equipment) and must be installed inside a conductive control panel. The tests were conducted with the programmable controller installed in a control panel.

*2 The accuracy of an analog-digital converter module may temporarily vary within $\pm 10\%$.

A

(2) Installation in a control panel

The module is open type devices and must be installed inside a control panel.

This ensures safety as well as effective shielding of programmable controller-generated electromagnetic noise.

(a) Control panel

- Use a conductive control panel.
- When securing the top or bottom plate using bolts, cover the grounding part on the control panel so that the part will not be painted.
- To ensure electrical contact between the inner plate and control panel, take measures such as covering the bolts so that conductivity can be ensured in the largest possible area.
- Ground the control panel with a thick ground cable so that low impedance can be ensured even at high frequencies.
- Holes in the control panel must be 10cm diameter or less. If the holes are larger than 10cm, radio wave may be emitted. In addition, because radio waves leak through a clearance between the control panel and its door, reduce the clearance as much as possible. The leakage of radio waves can be suppressed by the direct application of an EMI gasket on the paint surface.
Our tests have been carried out on a control panel having the attenuation characteristics of 37dB (max.) and 30dB (mean) (measured by 3m method, 30 to 300MHz).

(b) Wiring of power cables and ground cables

- Near the power supply part, provide a ground point to the control panel. Ground the FG terminal with the thickest and shortest possible ground cable (30cm or shorter).

(3) Cables

Use shielded cables for the cables which are connected to the module and run out from the control panel. If a shielded cable is not used or not grounded correctly, the noise immunity will not meet the specified value.

(a) Cables for the CC-Link IE Field Network

The precautions for using CC-Link IE Field Network cables are described below.

- Shielded cables should be used for the CC-Link IE Field Network. Strip a part of the jacket as shown below and ground the exposed shield in the largest possible area.

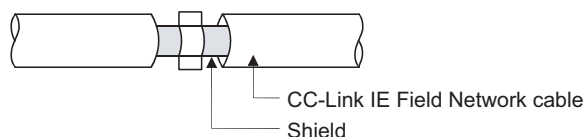

(b) Grounding the cable clamp

Use shielded cables for external wiring and ground the shields of the external wiring cables to the control panel with the AD75CK-type cable clamp (Mitsubishi). (Ground the shield section 20 to 30cm away from the module.)

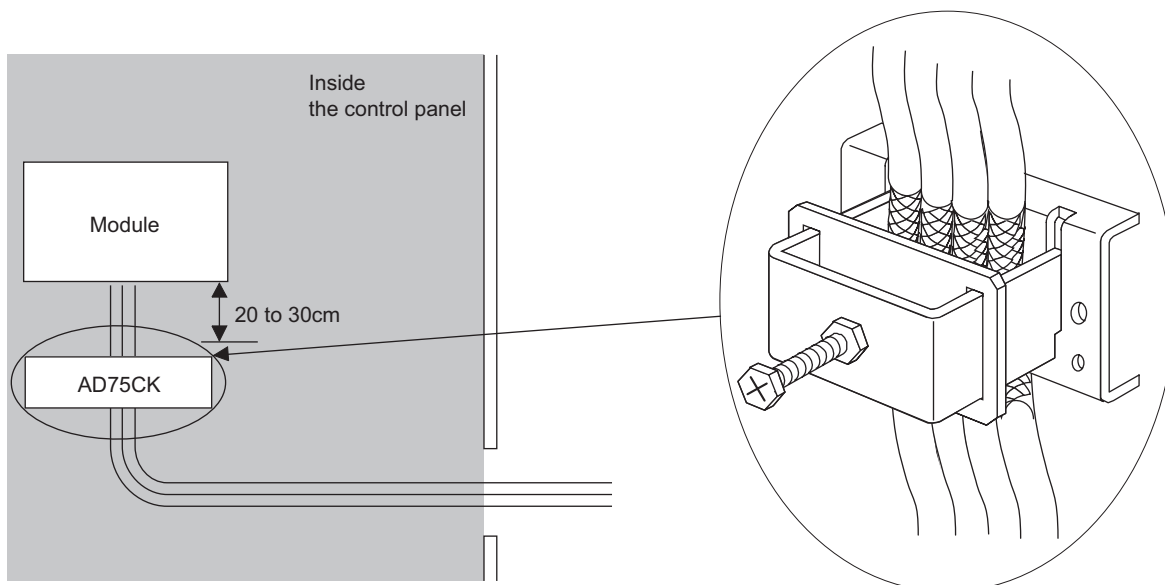

For details of the AD75CK, refer to the following.

 AD75CK-type Cable Clamping Instruction Manual

(c) Analog I/O signal line

Use a signal line of 30m or shorter when connecting it to the analog I/O terminals of the module.

A

(4) External power supply

- Use a CE-marked product for an external power supply and always ground the FG terminal. (External power supply used for the tests conducted by Mitsubishi: TDK-Lambda DLP-120-24-1, IDEC PS5R-SF24, PS5R-F24)
- Use a power cable of 10m or shorter when connecting it to the module power supply terminal.

(5) Others

(a) Ferrite core

A ferrite core has the effect of reducing radiated noise in the 30MHz to 100MHz band.

It is recommended to attach ferrite cores if shielded cables coming out of the control panel do not provide sufficient shielding effects.

Note that the ferrite cores must be attached at the position closest to the cable hole inside the control panel. If attached at an improper position, the ferrite core will not produce any effect.

For the FG terminal on a main module that is connected to the external power supply, the external power supply of an extension module, and CC-Link IE Field Network cables, attach a ferrite core 4cm away from the module.

(Ferrite core used for the tests conducted by Mitsubishi: NEC TOKIN ESD-SR-250, TDK ZCAT3035-1330)

Example

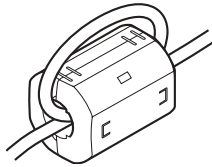

(b) Noise filter (power supply line filter)

A noise filter is a component which has an effect on conducted noise. Attaching the filter can suppress more noise. (The noise filter has the effect of reducing conducted noise of 10MHz or less.)

Connect a noise filter to the external power supply of a main module and the external power supply of an extension module. Use a noise filter with the damping characteristics equivalent to those of MA1206 (manufactured by TDK-Lambda Corporation). Note that a noise filter is not required if the module is used in Zone A defined in EN61131-2.

The precautions for attaching a noise filter are described below.

- Do not bundle the cables on the input side and output side of the noise filter. If bundled, the output side noise will be induced into the input side cables from which the noise was filtered.

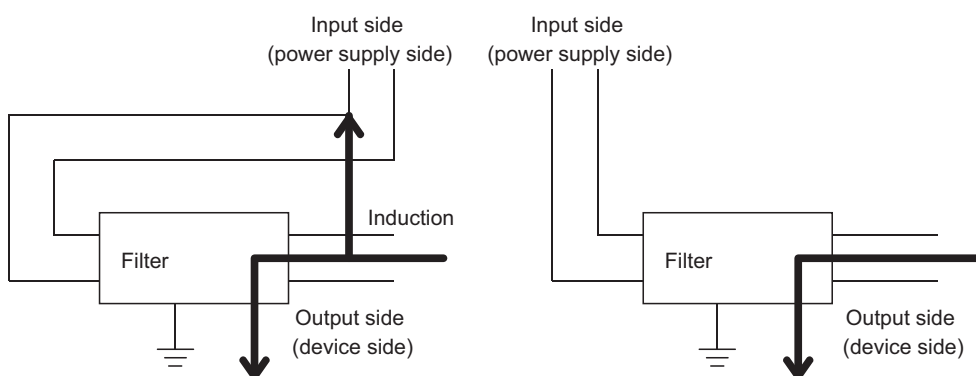

Noise will be induced when the input and output wires are bundled.

Separately install the input and output wires.

- Ground the noise filter grounding terminal to the control panel with the shortest cable possible (approx. 10cm).

A

Appendix 7.2 **Requirements to compliance with the Low Voltage Directive**

The module operates at the rated voltage of 24VDC.

The Low Voltage Directive is not applied to the modules that operate at the rated voltage of less than 50VAC and 75VDC.

Appendix 8 Checking Serial Number and Function Version

The serial number and function version of the D/A converter module can be checked on the rating plate on the side of the module.

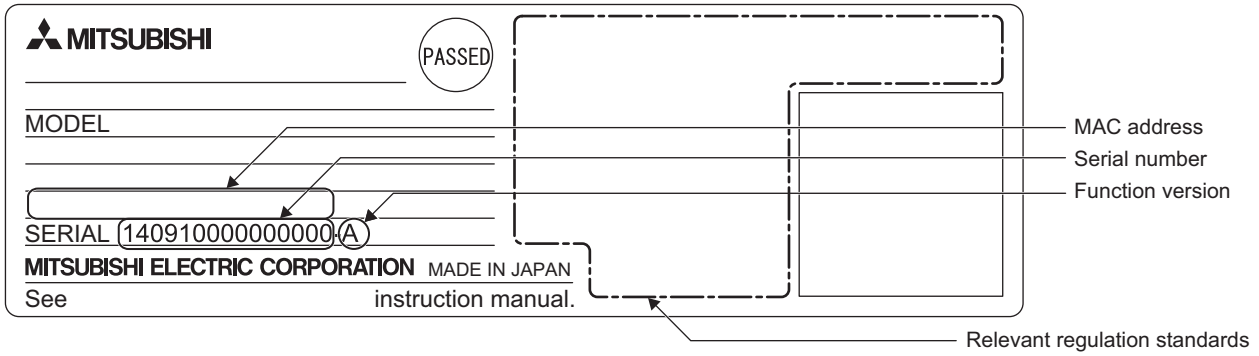

A

Appendix 8 Checking Serial Number and Function Version

Appendix 9 External Dimensions

The following shows the external dimensions of the D/A converter module.

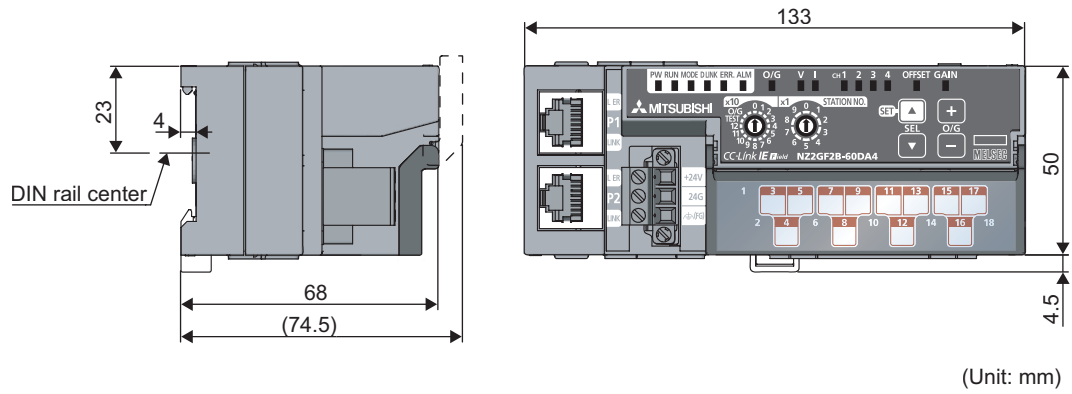

Memo

A

Appendix 9 External Dimensions

INDEX

Symbols

+/- button 21

A

Alarm code list 124
Alert output clear request flag (RY1E) 135
Alert output flag (RW_rA) 137
Alert output function 92
Alert output setting (address: 105_H) 146
Alert output signal (RX1E) 134
Alert output signal assignment (address: 0004_H) . . 140
ALM LED 20
Analog output HOLD/CLEAR function 76
Analog output HOLD/CLEAR setting
(address: 0104_H) 145
Applicable DIN rail model
(compliant with IEC 60715) 50
Applicable systems 44
 Applicable master station 44
 Connectable modules 44
 Ethernet cable 44
 Software package 44
Application 15

B

Bending radius of the Ethernet cable 56

C

Calculating current consumption 27
CC-Link IE Field Network diagnostic function . . . 102
CH1 to 4 LED 20
Checking for the error codes and the alarm codes
. 116
 Checking by executing a command of the slave
 station 116
 Checking by Latest error code (RW_r0) 118
 Checking by Latest warning code (RW_r1) 118
Checking the LEDs 125
CH□ Alert output lower limit value
(address: 0107_H, 0109_H, 010B_H, 010D_H) 146
CH□ Alert output upper limit value
(address: 0106_H, 0108_H, 010A_H, 010C_H) 146
CH□ Digital value (RW_w2 to RW_w5) 138
CH□ Output enable/disable flag (RY10 to RY13)
. 135
CH□ Scaling lower limit value
(address: 010F_H, 0111_H, 0113_H, 0115_H) 147
CH□ Scaling upper limit value
(address: 0110_H, 0112_H, 0114_H, 0116_H) 147
CH□ Set value check code (RW_r2 to RW_r5) 136
CH□ Shifting set value (RW_w6 to RW_w9) 139
Connecting extension modules 48
Connecting the Ethernet cable 54
Current output characteristics 154
Cyclic data update watch function 78

Cyclic data update watch time setting
(address: 0007_H) 143

D

D LINK LED 20
D/A conversion enable/disable function 74
D/A conversion enable/disable setting
(address: 0102_H) 144
D/A output enable/disable function 74
Details of remote I/O signals 131
Digital output HOLD/CLEAR setting
(address: 0011_H) 144
Digital output HOLD/CLEAR setting function 98
Digital value range check function 89
DIN rail hook 21
DIN rail stopper 51

E

ERR. LED 20
Error clear request flag (RYA) 135
Error code list 119
Error flag (RXA) 133
Error flag assignment (address: 0005_H) 141
Error history area (address: 0A00_H to 0FFF_H) 38
Error history clear command (address: 1000_H) . . . 149
Error history clear completed (address: 1001_H) . . . 149
Error history □ (address: 0A00_H to 0AEF_H) 148
Error notification function 95
External dimensions 164
External power supply monitor request flag (RY1F)
. 135
External power supply monitor state flag (RX1F) . . 134
External power supply monitoring function 98
External signal assignment function 99

F

Features 16
Function at the extension module installation 98

G

GAIN LED 20
Gain value 152
General specifications 23

I

I LED 20
Initial data setting completed flag (RX9) 132
Initial data setting request flag (RY9) 135
Input response time setting (address: 0010_H) 143
Input response time setting function 98
Installation and wiring 45
Installation direction 47
Installation environment 46
Installation environment and installation position . . 46

Installation position	46
L	
L ER LED	21
Latest error code (RWr0)	136
Latest warning code (RWr1)	136
Laying Ethernet cables	56
LINK LED	21
List of remote buffer memory	32
List of remote I/O signals	29
List of remote register	31
M	
Maintenance and inspection	114
Maximum station-to-station distance (Maximum Ethernet cable length)	56
Measures to comply with the EMC Directive	156
Cables	159
EMC Directive related standards	156
External power supply	160
Installation in a control panel	158
Others	160
MODE LED	20
Module control data area (address: 1000 _H to 14FF _H)	39
Module operation information initialization command (address: 1004 _H)	151
Module operation information initialization completed (address: 1005 _H)	151
Monitoring area (address: 0500 _H to 09FF _H)	36
Mounting the modules on a DIN rail	49
N	
Number of ON times integration function	98
O	
O/G LED	20
OFFSET LED	20
Offset value	152
Offset/Gain setting	72
P	
P1	21
P2	21
Packing list	14
Parameter area (address: 0000 _H to 04FF _H)	33
Parameter area initialization command (address: 1002 _H)	149
Parameter area initialization completed (address: 1003 _H)	150
Parameter setting	63
Part names	19
Performance specifications	25
Program example	106
Programming	105
Precautions for programming	105
Procedure for programming	106
PW LED	20

R	
Range setting (address: 0103 _H)	145
Range switching function	75
Remote READY (RXB)	134
Requirements to compliance with the Low Voltage Directive	162
RUN LED	20
S	
Scaling enable/disable setting (address: 010E _H)	147
Scaling function	79
SET/SEL button	21
Shift function	85
Station number setting	45
Station number setting switch	19
System configuration	43
T	
Term	12
Terminal block cover	21
Terminal block for analog output signals	21
Terminal block for module power supply and FG	21
The procedure before operation	41
Troubleshooting	116
Troubleshooting for each phenomenon	129
U	
Unit test	128
V	
V LED	20
Voltage output characteristics	153
W	
Warning flag (RX7)	131
Warning flag assignment (address: 0006 _H)	142
Wiring of Ethernet cable	54
Wiring of external device and terminal block	57
Wiring with terminal block for module power supply and FG	52

REVISIONS

*The manual number is given on the bottom left of the back cover.

Print date	*Manual number	Revision
November, 2012	SH(NA)-081112ENG-A	First edition

Japanese manual version SH-08111-A

This manual confers no industrial property rights or any rights of any other kind, nor does it confer any patent licenses. Mitsubishi Electric Corporation cannot be held responsible for any problems involving industrial property rights which may occur as a result of using the contents noted in this manual.

© 2012 MITSUBISHI ELECTRIC CORPORATION

WARRANTY

Please confirm the following product warranty details before using this product.

1. Gratis Warranty Term and Gratis Warranty Range

If any faults or defects (hereinafter "Failure") found to be the responsibility of Mitsubishi occurs during use of the product within the gratis warranty term, the product shall be repaired at no cost via the sales representative or Mitsubishi Service Company.

However, if repairs are required onsite at domestic or overseas location, expenses to send an engineer will be solely at the customer's discretion. Mitsubishi shall not be held responsible for any re-commissioning, maintenance, or testing on-site that involves replacement of the failed module.

[Gratis Warranty Term]

The gratis warranty term of the product shall be for one year after the date of purchase or delivery to a designated place.

Note that after manufacture and shipment from Mitsubishi, the maximum distribution period shall be six (6) months, and the longest gratis warranty term after manufacturing shall be eighteen (18) months. The gratis warranty term of repair parts shall not exceed the gratis warranty term before repairs.

[Gratis Warranty Range]

- (1) The range shall be limited to normal use within the usage state, usage methods and usage environment, etc., which follow the conditions and precautions, etc., given in the instruction manual, user's manual and caution labels on the product.
- (2) Even within the gratis warranty term, repairs shall be charged for in the following cases.
 1. Failure occurring from inappropriate storage or handling, carelessness or negligence by the user. Failure caused by the user's hardware or software design.
 2. Failure caused by unapproved modifications, etc., to the product by the user.
 3. When the Mitsubishi product is assembled into a user's device, Failure that could have been avoided if functions or structures, judged as necessary in the legal safety measures the user's device is subject to or as necessary by industry standards, had been provided.
 4. Failure that could have been avoided if consumable parts (battery, backlight, fuse, etc.) designated in the instruction manual had been correctly serviced or replaced.
 5. Failure caused by external irresistible forces such as fires or abnormal voltages, and Failure caused by force majeure such as earthquakes, lightning, wind and water damage.
 6. Failure caused by reasons unpredictable by scientific technology standards at time of shipment from Mitsubishi.
 7. Any other failure found not to be the responsibility of Mitsubishi or that admitted not to be so by the user.

2. Onerous repair term after discontinuation of production

- (1) Mitsubishi shall accept onerous product repairs for seven (7) years after production of the product is discontinued.

Discontinuation of production shall be notified with Mitsubishi Technical Bulletins, etc.
- (2) Product supply (including repair parts) is not available after production is discontinued.

3. Overseas service

Overseas, repairs shall be accepted by Mitsubishi's local overseas FA Center. Note that the repair conditions at each FA Center may differ.

4. Exclusion of loss in opportunity and secondary loss from warranty liability

Regardless of the gratis warranty term, Mitsubishi shall not be liable for compensation of damages caused by any cause found not to be the responsibility of Mitsubishi, loss in opportunity, lost profits incurred to the user by Failures of Mitsubishi products, special damages and secondary damages whether foreseeable or not, compensation for accidents, and compensation for damages to products other than Mitsubishi products, replacement by the user, maintenance of on-site equipment, start-up test run and other tasks.

5. Changes in product specifications

The specifications given in the catalogs, manuals or technical documents are subject to change without prior notice.

Microsoft, Windows, Windows NT, and Windows Vista are registered trademarks of Microsoft Corporation in the United States and other countries.

Pentium is a trademark of Intel Corporation in the United States and other countries.

Ethernet is a trademark of Xerox Corporation.

All other company names and product names used in this manual are trademarks or registered trademarks of their respective companies.

CC-Link IE Field Network Digital-Analog Converter Module User's Manual

MODEL	CCIEF-DA-U-E
MODEL CODE	13JZ81
SH(NA)-081112ENG-A(1211)MEE	



HEAD OFFICE : TOKYO BUILDING, 2-7-3 MARUNOUCHI, CHIYODA-KU, TOKYO 100-8310, JAPAN
NAGOYA WORKS : 1-14, YADA-MINAMI 5-CHOME, HIGASHI-KU, NAGOYA, JAPAN

When exported from Japan, this manual does not require application to the Ministry of Economy, Trade and Industry for service transaction permission.

Specifications subject to change without notice.